

PREPARED FOR SUBMISSION TO JINST

21<sup>ST</sup> INTERNATIONAL WORKSHOP ON RADIATION IMAGING DETECTORS

7-12 JULY 2019

KOLYMPARI, CHANIA, CRETE, GREECE

## Runaway Electron Diagnostics Using Silicon Strip Detector

---

**L. Novotny,<sup>a,1</sup> J. Cerovsky,<sup>a,b</sup> P. Dhyani,<sup>a</sup> O. Ficker,<sup>a</sup> M. Havranek,<sup>a</sup> M. Hejtmanek,<sup>a</sup>  
Z. Janoska,<sup>a</sup> V. Kafka,<sup>a</sup> S. Kulkov,<sup>a</sup> M. Marcisovska,<sup>a</sup> M. Marcisovsky,<sup>a</sup> G. Neue,<sup>a</sup> P. Svihra,<sup>a</sup>  
V. Svoboda,<sup>a</sup> L. Tomasek,<sup>a</sup> M. Tunkl,<sup>a</sup> V. Vrba<sup>a</sup>**

<sup>a</sup>*Department of Physics, Faculty of Nuclear Sciences and Physical Engineering, Czech Technical University, Brehova 78/7, 115 19 Prague, Czech Republic*

<sup>b</sup>*Institute of Plasma Physics, Czech Academy of Sciences, Za Slovankou 1782/3, 182 00 Prague, Czech Republic*

*E-mail:* [Lukas.Novotny@fjfi.cvut.cz](mailto:Lukas.Novotny@fjfi.cvut.cz)

**ABSTRACT:** We present a proof-of-principle measurement of runaway electrons in a small tokamak using a silicon strip detector. The detector was placed inside the diagnostic port of the tokamak vessel and detected the runaway electron signal directly. The measured signal was compared to the signal provided by other tokamak diagnostics, especially the hard X-ray scintillation detector, which detects secondary photons created by interaction of accelerated electrons with tokamak walls (indirect detection of runaway electrons). The preliminary results show that when not saturated, direct detection with a segmented silicon strip detector provides promising new diagnostic information including spatial and temporal distribution of the runaway electron beam, and the measurement results are in good agreement with hard X-ray measurements with a scintillation detector.

**KEYWORDS:** Hybrid detectors, Plasma diagnostics - charged-particle spectroscopy

---

<sup>1</sup>Corresponding author.

---

## Contents

<b>1</b>	<b>Introduction</b>	<b>1</b>
<b>2</b>	<b>The PH32-based detector</b>	<b>2</b>
2.1	The strip sensor	2
2.2	The readout chip	2
<b>3</b>	<b>The GOLEM tokamak</b>	<b>3</b>
<b>4</b>	<b>Experimental setup</b>	<b>4</b>
<b>5</b>	<b>Measurement results</b>	<b>5</b>
<b>6</b>	<b>Conclusions</b>	<b>6</b>

---

## 1 Introduction

Runaway electrons (RE) are created when the electrons in plasma are accelerated by a toroidal electric field up to tens of MeV in the case of large tokamaks [1]. This usually happens during discharge disruption, when the plasma current suddenly falls and the plasma hits the tokamak wall. RE pose a threat to tokamaks due to the localized energy deposition to the plasma facing tokamak components by a large current of relativistic electrons.

Semiconductor radiation detectors are widely used in high-energy physics research and industry. The application of semiconductor detectors for RE measurement seeks to gain operation experience by employing the strip-based silicon detector alongside the existing tokamak diagnostic instruments. The harsh environment of the tokamak discharge allows testing of the response of the silicon strip detectors in large-amplitude electromagnetic fields and in wide dynamic and energy ranges of the signal.

The segmented semiconductor detector employed in this measurement is a hybrid strip detector composed of a silicon sensor wire-bonded to the PH32 readout ASIC [2]. The detector was installed in a transversal?? diagnostic port inside the vessel of the GOLEM tokamak [3].

These RE studies should result in fabrication of a new instrument for RE diagnostics. Thanks to the detection properties of silicon detectors, the new information should provide insight and better understanding of the RE creation processes, following up the work presented in [4].

## 2 The PH32-based detector

The PH32-based detector is a hybrid strip detector, consisting of the silicon strip sensor and the PH32 readout chip, connected by the wire bonding (see figure 1).

Communication between the PH32 ASIC and the computer, enabling configuration of the PH32 chip and data read-out, is provided by the Simple USB 2.0 Readout Environment (SURE) data acquisition readout card.

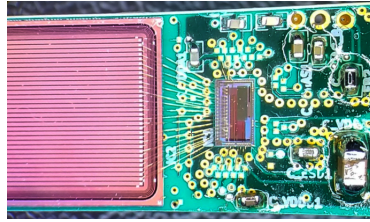

**Figure 1.** The silicon strip sensor connected to the PH32 readout chip by wire bonding.

The PH32 readout chip allows operation modes of hit counting or measurement of the deposited energy (ToT mode). The ASIC has the possibility of changing the front-end amplification factor by selecting from two operating modes. The high gain mode (HGM) is mostly sensitive to low deposited energies ( $4 - 40 \text{ ke}^-$ ) and it is suitable for the detection of X-rays, gamma radiation and electrons. On the other hand, the low gain mode (LGM) is only sensitive to large signal amplitudes (creating  $0.1 - 7 \text{ Me}^-$ ) and it is typically used for detection of charged ions with large specific energy loss.

## 2.1 The strip sensor

The silicon  $n^+$ -in-p sensor consists of 32 AC coupled strips. The dimensions of each strip are  $250 \mu\text{m} \times 18 \text{ mm}$  and the sensor thickness is  $525 \mu\text{m}$ . The sensor is manufactured on a high-resistivity substrate ( $17 \text{ k}\Omega \cdot \text{cm}$ ), which ensures that the sensor volume is fully depleted at the voltage of approximately  $-160 \text{ V}$ .

## 2.2 The readout chip

The PH32 readout chip was designed as a front-end readout of silicon strip sensors. The chip was manufactured in a 180 nm CMOS process and it has dimension of  $3.5 \times 2 \text{ mm}^2$ . The chip can service 32 input channels and communicates over SPI-compatible bus. The ASIC was designed to operate with p-type sensors; therefore, it is optimized for electron readout. The circuit for each input channel consists of the analog and digital part.

The analog part of the ASIC is depicted in figure 2. The main channel circuit consists of Charge Sensitive Amplifier (CSA) directly communicating with the sensor and the gain is adjustable. The CSA also has an input for the external charge injection used for the calibration the channel (injection capacitance  $10 \text{ fF}$  for HGM and  $1 \text{ pF}$  for LGM). The analog output of the CSA of one of the channels can be selected to be routed to the analog out pin of the ASIC for the diagnostic purposes. In this work, it was connected to the oscilloscope which visualized outputs of various tokamak diagnostics.

The signal leaving the CSA reaches the discriminator, where it is compared with the adjustable globally set threshold. The threshold in each channel is equalized by the Threshold DAC (TDAC). After the signal passes through the discriminator, it is digitized by the Time over Threshold (ToT) method with clocks generated by an internal oscillator.

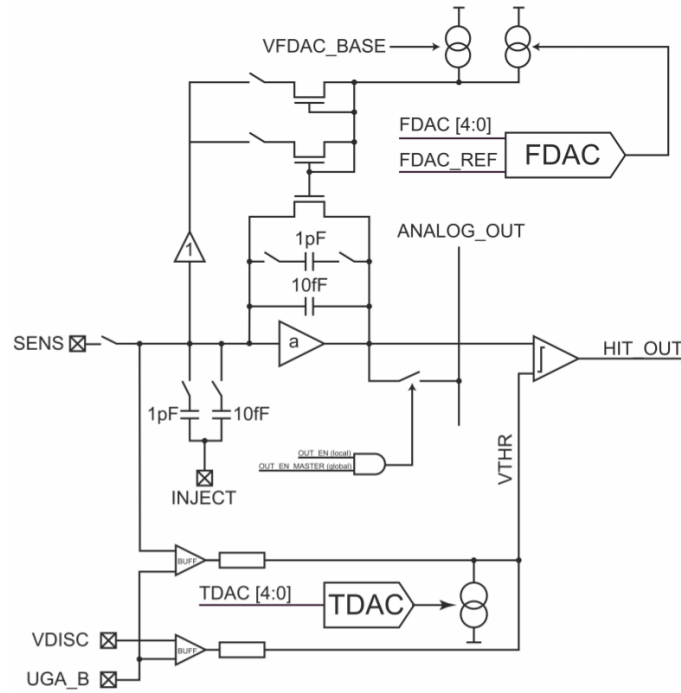

**Figure 2.** Block schematic design of the analog part of one channel PH32 chip [2].

The ToT information is sent from the analog part to the digital part of the ASIC, where it is processed according to the preset channel operating mode - hit counting, energy integrated during measurement, energy of first hit or time of the arrival of the first hit. The measured data are stored in a 16-bit asynchronous counter and are moved to the shift register after the end of exposure.

### 3 The GOLEM tokamak

The GOLEM tokamak is the oldest actively operated tokamak of its kind in the world. Its history started in the 1960s, when it was built at the Kurchatov Institute in Russia under the name TM1-MH. In 1977, it was moved to the Institute of Plasma Physics of the Czech Academy of Sciences in Prague where it operated under the name CASTOR. In 2007, the tokamak was moved to the Faculty of Nuclear Sciences and Physical Engineering of the Czech Technical University in Prague (FNSPE CTU) and it was renamed GOLEM.

Nowadays, GOLEM (see figure 3) serves both educational and research purposes. Due to its compact size (major radius  $R = 0.4$  m, minor radius  $a = 8.5$  cm, maximal toroidal field  $B_t < 0.6$  T, plasma current in the flat-top phase  $I_p < 8$  kA and plasma discharge duration  $t \approx 20$  ms), it is a suitable device to test the functionality of the semiconductor detectors in the tokamak environment close to the plasma surface. In addition, the RE current generated by this tokamak is orders of magnitude lower than the RE current in large devices.

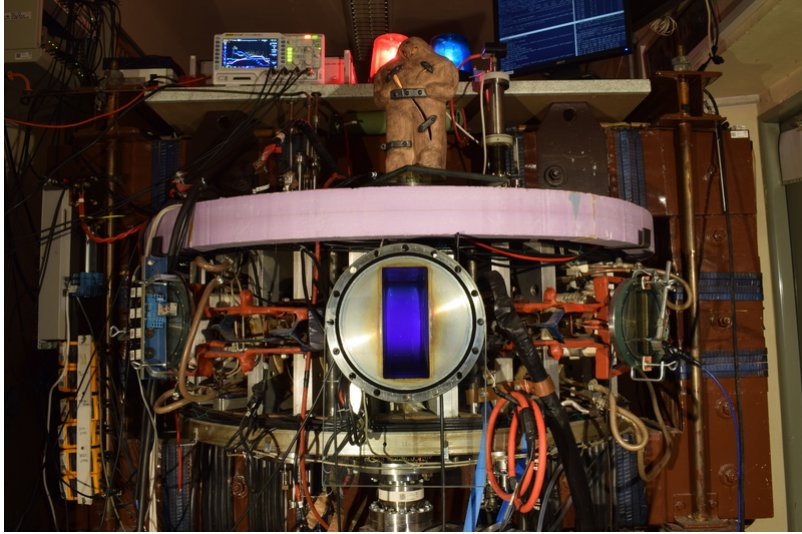

**Figure 3.** Image of the GOLEM tokamak at the FNSPE CTU during the discharge.

## 4 Experimental setup

The PH32 silicon strip detector was used for direct detection of the RE created in the GOLEM tokamak. The detector was placed on the radial manipulator, providing the possibility to choose the angle between the detection area and the plasma current as well as the possibility to change the distance between the detector and the tokamak wall. In order to shield the detector from soft X-rays, it was placed in a 2 mm thick aluminum box with a sensor window made of aluminum foil with the thickness of 10  $\mu\text{m}$ .

Due to the harsh electromagnetic pulse (EMP) environment, the communication was provided via an optical USB cable powered by a power bank. The sensor was partially depleted using the bias voltage of  $-120\text{ V}$ .

The digital output was used along with the analog output from a single strip. The analog output of one PH32 strip was compared to the data from a standard RE detection technique, using hard X-ray (HXR) NaI(Tl) scintillation detector which was placed outside the vessel near the limiter.

Since a large number of detected particles was expected, the readout mode of the detector was set to the LGM. The 25th strip was connected to the oscilloscope and its analog output was compared to the signal measured by the HXR NaI(Tl). The wire-bonds, connecting the 13th and 14th strip of the sensor to the readout ASIC were broken; therefore, the signal from corresponding channels is not included in further analysis. The digital readout is turned on by the trigger coming 5 ms before the magnetic field ramp-up. Afterwards, 300 frames are read-out and stored in the output file in the form of a number of hits of ToT per each strip. The time between each frame can be set; for the RE measurement it was set to 200  $\mu\text{s}$ , limited by the shutter for defined acquisition time.

## 5 Measurement results

Both hit counting mode and ToT mode were tested and they detected signal. In most of the tokamak shots, the signal from PH32 detector is in good agreement with the HXR diagnostics, as shown in figures 4 and 5. From the ToT, it is possible to estimate the energy of the detected particle by using the fact that the length and height of the pulse is equivalent to the amount of charge created by the passing of ionizing particle.

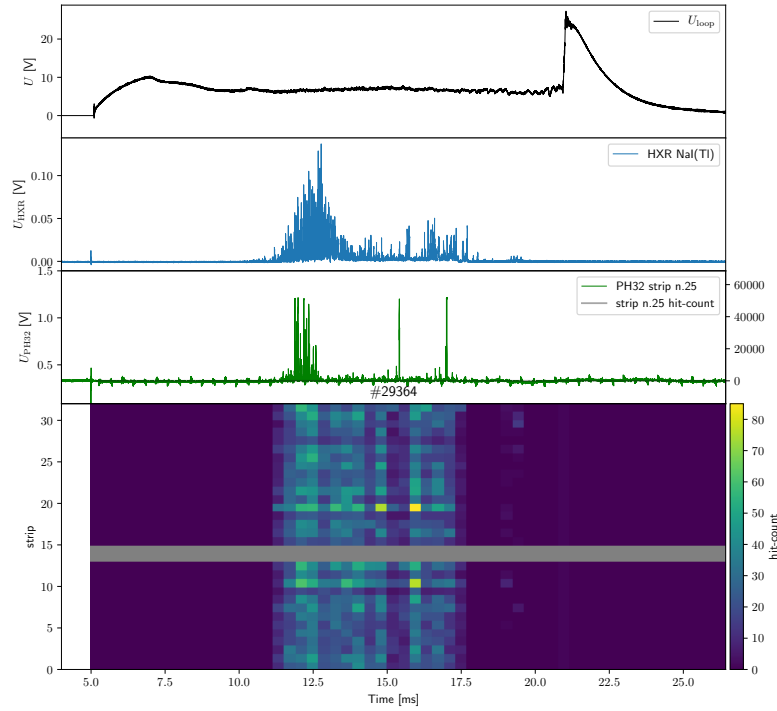

**Figure 4.** Shot number 29364, the PH32 detector in the LGM collected a number of hits, the  $U_{loop}$  is the loop voltage of plasma discharge. The second plot shows the HXR scintillation, the third plot shows the analog signal voltage in the 25th strip and the last plot shows the number of hits in all strips.

Figure 6 shows the signal saturation, which was sometimes observed. This can be caused by plasma touching directly the electronics around the chip, because the plasma was very close to the shielding box. So in the events with saturation, it is possible that the plasma directly hit this box. When the sensor was moved further from plasma, direct RE were shielded by the limiter of the tokamak and only X-rays from interaction of RE with limiter were detected. Despite the saturation, the bottom part of figure 6 shows good spatial positioning of the plasma and provides promising possibilities of studying properties of the RE.

Another observed situation is presented in figure 7 where some type of measured electromagnetic interferences are shown. The upper part shows the detected peak, which corresponds to time of turning on of the thyristors (ramping the magnetic field up). This peak was observed in all measurements, even if the plasma (and RE) was not created, but it has no effect on detecting the RE itself. The middle and bottom part of figure 7 shows the periodical noise that appears only when the digital reading of the data is turned on and the data are transferred from PH32 registers into SURE.

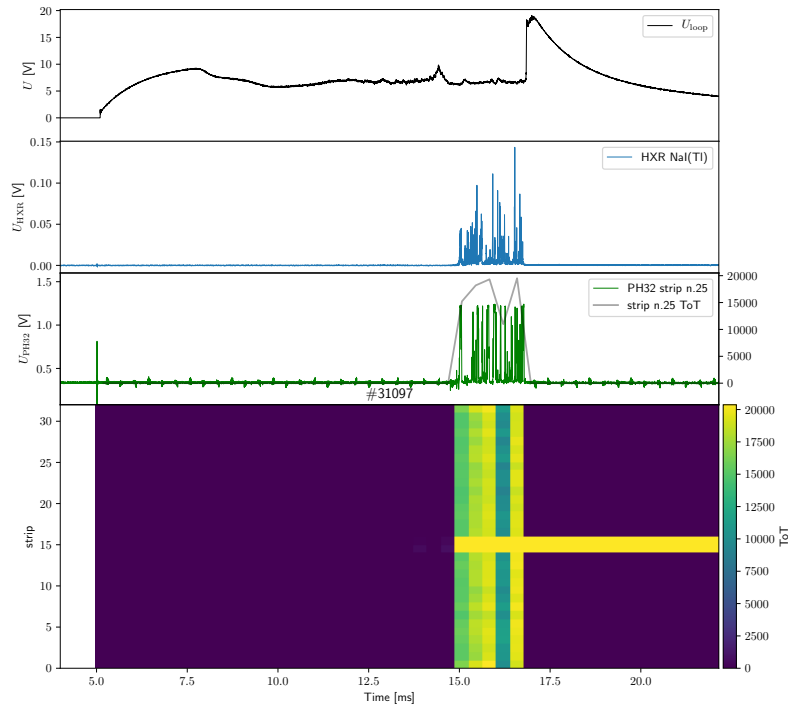

**Figure 5.** Shot number 31097, the PH32 detector in the LGM collected a number of hits, the  $U_{loop}$  is the loop voltage of plasma discharge. The second plot shows the HXR scintillation, the third plot shows the analog signal voltage in the 25th strip and the last plot shows the number of hits per time window for all strips.

This noise is caused by the induction of chip control signals in electronic circuits and ground loop while PH32 communicates with SURE. The induction was probably detected by the oscilloscope, because it was connected to the same ground.

Regardless of the manifested difficulties, the PH32-based silicon strip detector shows promising results in the area of plasma diagnostics. For future experiments, the printed circuit board will be modified in order to eliminate the possibility of being accidentally hit by the plasma, but to still enable direct detection of RE. The shielding box will be upgraded to lower the measurements with the saturated detected signal. Another goal is to shorten the death time by half of nowadays value.

## 6 Conclusions

The PH32 strip detector has been tested in the GOLEM tokamak RE campaign in both hit counting and ToT modes. A successful in vacuo operation of the silicon strip detector setup has been demonstrated. Full data analysis is being performed; however, preliminary results show that direct RE measurements are in good agreement with the indirect measurements using the NaI(Tl) scintillation detectors. The ToT measurements showed saturation even in the low gain mode and ways to reduce signal amplitude are being implemented. The semiconductor detectors have proven to be a functional addition to the existing plasma diagnostics methods and have been integrated in the data acquisition systems. Since the potential of semiconductor radiation detectors in plasma physics research has not been fully exploited, their application will be studied further.

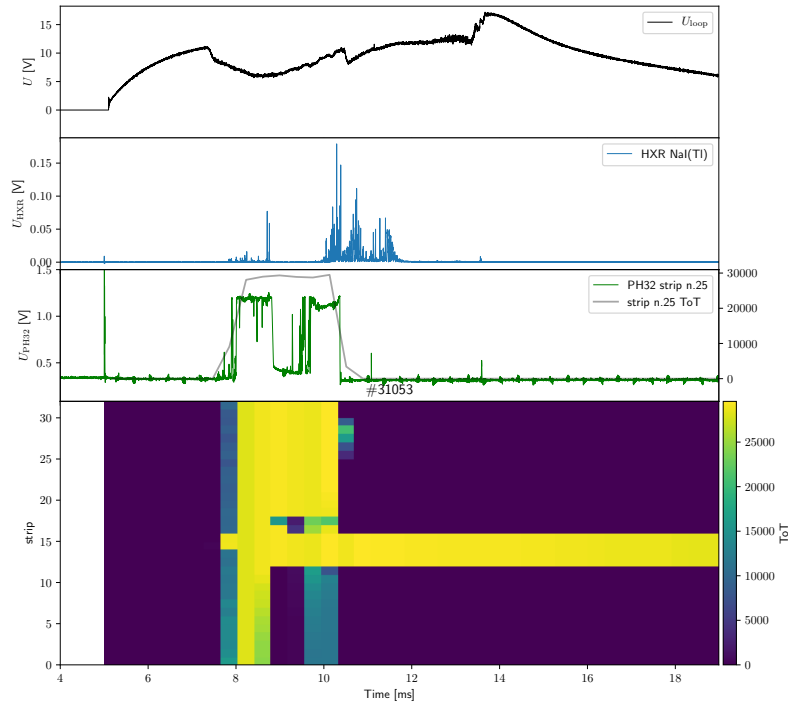

**Figure 6.** Shot number 29364, detector collected number of hits in the LGM.  $U_{loop}$  is loop voltage of plasma discharge. The second plot shows the HXR scintillation, third plot shows the saturation of analog signal voltage in the 25th strip and the last plot shows ToT for all of the strips with demonstration of the space resolution of signal.

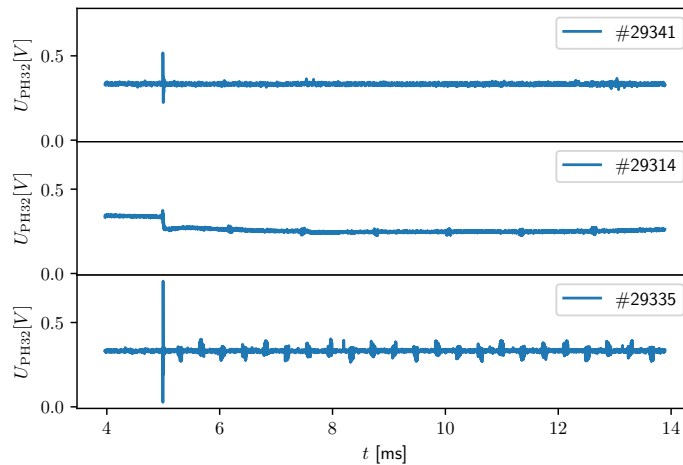

**Figure 7.** Detected noise. First plot shows peak created by the magnetic field ramp up. The second and third plot show by reading the data by SURE with 1090  $\mu$ s long shutter (shot 29314) and 200  $\mu$ s long shutter (shot 29335).



## Acknowledgments

This work has been supported by grant No. GA18-02482S from Czech Science Foundation.

## References

- [1] H. Knoepfel, D. Spong, *Runaway electrons in toroidal discharges*, *Nucl. Fusion* **19**, (1979) 6.
- [2] Z. Janoska et al., *Measurement of ionizing particles by the PH32 chip*, *2015 IEEE Nuclear Science Symposium and Medical Imaging Conference (NSS/MIC)*, (2015) 1-5.
- [3] V. Svoboda et al., *Remote operation of the GOLEM tokamak for Fusion Education*, *Fusion Eng. Design* **112**, (2016) 1038-1044.
- [4] P. Svihra et al., *Runaway electrons diagnostics using segmented semiconductor detectors*, *Fusion Eng. Design* **146, Part A**, (2019) 316-319.