

# PKR 251

Compact FullRange™ Gauge, FPM sealed

## Operating Instructions

## Product Identification

In all communications with Pfeiffer Vacuum, please specify the information given on the product nameplate.

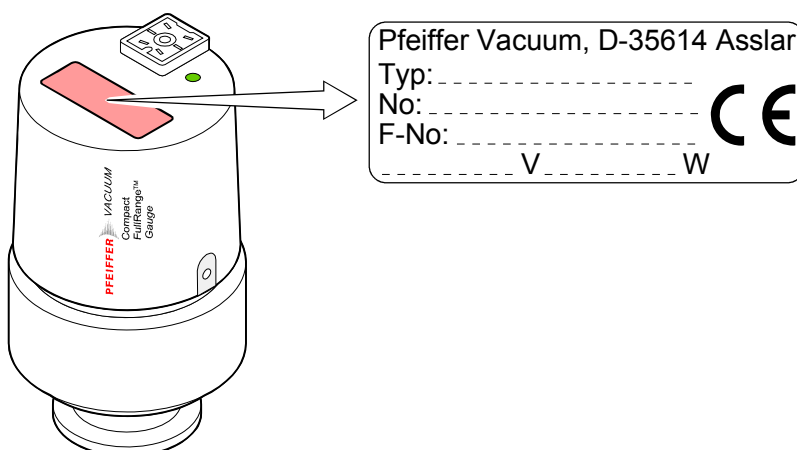

## Validity

This document applies to products with part number

PT R26 000	(DN 25 ISO-KF flange)
PT R26 001	(DN 40 ISO-KF flange)
PT R26 002	(DN 40 CF-F flange)

The part number can be taken from the product nameplate.

We reserve the right to make technical changes without prior notice.

## Intended Use

The PKR 251 Compact FullRange™ Gauge has been designed for vacuum measurement in the pressure range of  $5 \times 10^{-9}$  ... 1000 mbar.

It must not be used for measuring flammable or combustible gases in mixtures containing oxidants (e.g. atmospheric oxygen) within the explosion range.

The PKR 251 can be used with a Pfeiffer Vacuum measurement unit for Compact Gauges or with another evaluation unit.



## Functional Principle

Over the whole measurement range, the measuring signal is output as a logarithm of the pressure.

The PKR 251 gauge consists of two separate measurement systems (the Pirani and the cold cathode system according to the inverted magnetron principle). They are combined in such a way that for the user, they behave as one single measurement system.

# Contents

Product Identification	2
Validity	2
Intended Use	2
Functional Principle	2
<b>1 Safety</b>	<b>4</b>
1.1 Symbols Used	4
1.2 Personnel Qualifications	4
1.3 Safety Information	4
1.4 Liability and Warranty	5
<b>2 Technical Data</b>	<b>6</b>
<b>3 Installation</b>	<b>9</b>
3.1 Installation	9
3.1.1 Removing the Magnet Unit (Only for Gauges With CF Flanges)	10
3.2 Electrical Connection	11
3.2.1 Use With a Pfeiffer Vacuum Measurement Unit	11
3.2.2 Use With Another Evaluation Unit	11
<b>4 Operation</b>	<b>13</b>
4.1 Measurement Principle, Measuring Behavior	13
<b>5 Maintenance</b>	<b>15</b>
5.1 Adjusting the Gauge	15
5.2 Cleaning the Gauge / Replacing Parts	16
5.2.1 Disassembling the Gauge	17
5.2.2 Cleaning the Gauge	18
5.2.3 Reassembling the Gauge	19
5.3 What to Do in Case of Problems	20
<b>6 Removing the Gauge From the Vacuum System</b>	<b>21</b>
<b>7 Returning the Product</b>	<b>22</b>
<b>8 Accessories</b>	<b>22</b>
<b>9 Spare Parts</b>	<b>23</b>
<b>10 Disposal</b>	<b>23</b>
<b>Appendix</b>	<b>24</b>
A: Measuring Signal vs. Pressure	24
B: Gas Type Dependence	26

For cross references within this document, the symbol (→  XY) is used, for references to other documents, the symbol (→  [Z]).

# 1 Safety

## 1.1 Symbols Used



**DANGER**

Information on preventing any kind of physical injury.



**WARNING**

Information on preventing extensive equipment and environmental damage.



**Caution**

Information on correct handling or use. Disregard can lead to malfunctions or minor equipment damage.

## 1.2 Personnel Qualifications



**Skilled personnel**

All work described in this document may only be carried out by persons who have suitable technical training and the necessary experience or who have been instructed by the end-user of the product.

## 1.3 Safety Information

- Adhere to the applicable regulations and take the necessary precautions for the process media used.  
Consider possible reactions between the materials (→ 8) and the process media.  
Consider possible reactions of the process media due to the heat generated by the product.
- Adhere to the applicable regulations and take the necessary precautions for all work you are going to do and consider the safety information in this document.
- Before you begin to work, find out whether any vacuum components are contaminated. Adhere to the relevant regulations and take the necessary precautions when handling contaminated parts.



**DANGER**



**DANGER: magnetic fields**

Strong magnetic fields can disturb electronic devices like heart pacemakers or impair their function.



Maintain a safety distance of  $\geq 10$  cm between the magnet and the heart pacemaker or prevent the influence of strong magnetic fields by antimagnetic shielding.

Pass on the safety information to other users.

## 1.4 Liability and Warranty

Pfeiffer Vacuum assumes no liability and the warranty becomes null and void if the custodian or third parties

- disregard the information in this document
- use the product in a non-conforming manner
- make any kind of changes (modifications, alterations etc.) to the product
- use the product with accessories not listed in the corresponding product documentation.

The custodian assumes the responsibility in conjunction with the process media used.

Gauge failures due to contamination or wear and tear, as well as expendable parts (e.g. filament), are not covered by the warranty.

## 2 Technical Data

Admissible temperatures	
Storage	-40 °C ... +65 °C
Operation	+ 5 °C ... +55 °C
Bakeout	+150 °C (without electronics unit and magnetic shielding)
Relative humidity	max. 80% at temperatures $\leq +31$ °C decreasing to 50% at +40 °C
Use	indoors only altitude up to 2000 m (6600 ft)

Measurement range (air, N <sub>2</sub> )	$5 \times 10^{-9}$ ... 1000 mbar
Accuracy	$\approx \pm 30\%$ in the range $1 \times 10^{-8}$ ... 100 mbar
Reproducibility	$\approx \pm 5\%$ in the range $1 \times 10^{-8}$ ... 100 mbar
Gas type dependence	→ Appendix B

Adjustment	(→  15)
Pirani measurement circuit	
<HV> trimmer potentiometer	at $< 1 \times 10^{-4}$ mbar (while depressing the pin)
<ATM> trimmer potentiometer	at atmospheric pressure
Cold cathode measurement circuit	no adjustment (the gauge is adjusted at the factory and requires no maintenance)

Type of protection	IP 40
Maximum pressure (absolute)	10 bar only for inert gases $< 55$ °C

### Supply

**DANGER**



The gauge may only be connected to supply or measurement units that conform to the requirements of a grounded protective extra-low voltage (SELV). The connection to the gauge has to be fused.<sup>1)</sup>

Voltage at the gauge	15.0 ... 30.0 VDC (max. ripple 1 V <sub>pp</sub> )
Power consumption	$\leq 2$ W
Fuse <sup>1)</sup>	$\leq 1$ AT
The minimum voltage of the power supply must be increased proportionally to the length of the measuring cable.	
Voltage at the supply unit with maximum cable length	16.0 ... 30.0 VDC (max. ripple 1 V <sub>pp</sub> )

Electrical connection	Hirschmann compact connector type GO 6, 6 pins, male
Cable	5 poles plus screening
Maximum cable length	75 m (0.25 mm <sup>2</sup> conductor) 100 m (0.34 mm <sup>2</sup> conductor) 300 m (1.0 mm <sup>2</sup> conductor)

<sup>1)</sup> Pfeiffer Vacuum measurement and control units for Compact Gauges fulfill these requirements.

Operating voltage (in the measuring chamber)	≤3.3 kV
Operating current (in the measuring chamber)	≤500 μA
Output signal (measuring signal)	
Voltage range	≈0 V ... ≈+10.5 V
Relationship voltage-pressure	logarithmic, increase 0.6 V / decade (→ Appendix A)
Error signals	<0.5 V (no supply) >9.5 V (Pirani measurement element defective; filament rupture)
Output impedance	2×10 Ω
Minimum load	10 kΩ, short-circuit proof
Response time	pressure dependent
p > 10 <sup>-6</sup> mbar	≈10 ms
p = 10 <sup>-8</sup> mbar	≈1 s
Gauge identification	→ Figure 1
Pirani-only mode	11.1 kΩ resistor referenced to supply common
Combined Pirani / cold cathode mode	9.1 kΩ resistor referenced to supply common
The following conditions must be fulfilled:	
Polarity	The polarity of pin 1 referenced to supply common is always positive.
Measurement	
with constant current	measurement current within range 0.2 ... 0.3 mA
with constant voltage	measurement voltage within range 2 ... 3 V
Grounding concept	→ Figure 1
Vacuum flange-measurement common	connected via 10 kΩ (max. voltage differential with respect to safety ±50 V with respect to accuracy ±10 V)
Supply common-signal common	conducted separately; differential measurement recommended for cable lengths ≥6 m

PT R26 000 (DN 25 ISO-KF)

Materials exposed to the vacuum

Flange	stainless steel (1.4104)
Measuring chamber	stainless steel (1.4104)
Feedthrough isolation	ceramic (Al <sub>2</sub> O <sub>3</sub> ), glass
Internal seals	FPM75
Anode	Mo
Ignition aid	stainless steel (1.4310/AISI 301)
Pirani measuring tube	Ni, Au
Pirani filament	W

Internal volume ≈ 20 cm<sup>3</sup>

Dimensions [mm]

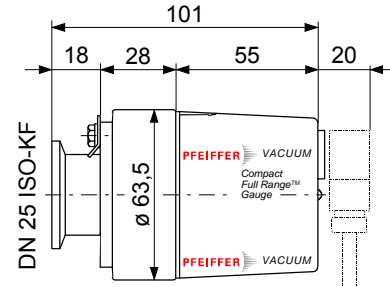

Weight 700 g

PT R26 001 (DN 40 ISO-KF)  
PT R26 002 (DN 40 CF-F)

Materials exposed to the vacuum

Flange	stainless steel (1.4306/AISI 304L)
Measuring chamber	stainless steel (1.4104)
Feedthrough isolation	ceramic (Al <sub>2</sub> O <sub>3</sub> ), glass
Internal seals	FPM75
Anode	Mo
Ignition aid	stainless steel (1.4310/AISI 301)
Pirani measuring tube	Ni, Au
Pirani filament	W

Internal volume ≈ 20 cm<sup>3</sup>

Dimensions [mm]

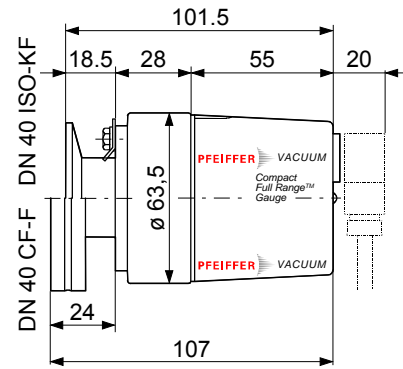

Weight 700 g (DN 40 ISO-KF flange)  
950 g (DN 40 CF-F flange)



### 3 Installation

#### 3.1 Installation

 **Caution**



Caution: vacuum component  
 Dirt and damages impair the function of the vacuum component.  
 When handling vacuum components, take appropriate measures to ensure cleanliness and prevent damages.

The gauge can be mounted in any orientation. However, it should be mounted so that any particles present cannot penetrate into the measuring chamber (→ 14). See "Technical data" (→ 8) for space requirements.

#### Procedure

- 1 Remove the protective cap.



The protective cap will be needed for maintenance work.

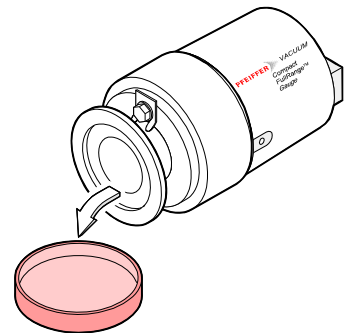

- 2 Make the flange connection.

When making a CF flange connection, it can be advantageous to temporarily remove the magnet unit (→ section 3.1.1).

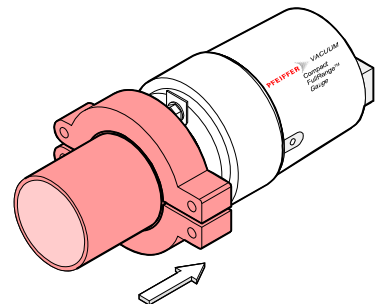

If it should be possible to adjust the gauge while it is connected to the vacuum system, make sure the two <HV> and <ATM> trimmer potentiometers are accessible for a screw driver.

 **DANGER**



DANGER: overpressure in the vacuum system >2.5 bar  
 KF flange connections with elastomer sealing rings (e.g. O-rings) cannot withstand such pressures. Process media can thus leak and possibly damage your health.  
 Use sealing rings provided with an outer centering ring.

 **DANGER**



DANGER: overpressure in the vacuum system >1 bar  
 If clamps are opened unintentionally injury can be caused by catapulted parts.  
 Use the type of clamps which can only be opened and closed by means of a tool (e.g. hose clip clamping ring).

**STOP DANGER**

The gauge must be electrically connected to the grounded vacuum chamber. The connection must conform to the requirements of a protective connection according to EN 61010:

- CF flanges fulfill this requirement
- For gauges with KF flanges, use a conductive metallic clamping ring.

**WARNING**

WARNING: electric arcing

Helium may cause electric arcing with detrimental effects on the electronics of the product.

Before performing any tightness tests put the product out of operation and remove the electronics unit.

### 3.1.1 Removing the Magnet Unit (Only for Gauges With CF Flanges)

Tools required

- Allen wrench AF 1.5
- Open-end wrench AF 7

Procedure

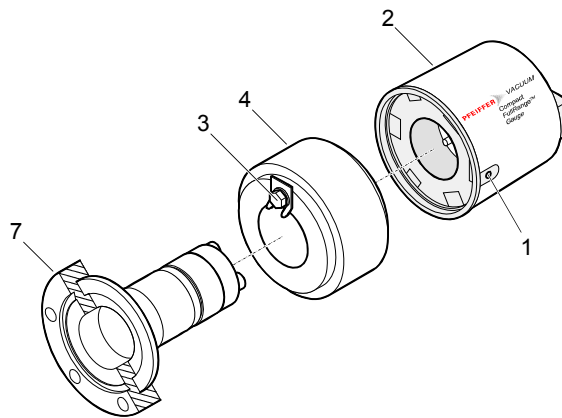

- 1 Unfasten the hexagon socket set screw (1) on the side of the electronics unit (2).
- 2 Remove the electronics unit **without twisting it**.
- 3 Unfasten the hexagon head screw (3) on the magnet unit (4) and remove the magnet unit.

**Caution**

The magnetic force and the tendency to tilt make it more difficult to separate the magnet unit and the measuring chamber (7).

- 4 Make the flange connection between the gauge and the vacuum system.

- 5 Remount the magnet unit and lock it with the hexagon head screw (3).
- 6 Carefully mount the electronics unit (2). (Make sure the pin of the Pirani element is properly plugged into the corresponding hole of the electronics unit.)
- 7 Push the electronics unit up to the mechanical stop and lock it with the hexagon socket set screw (1).

## 3.2 Electrical Connection

### 3.2.1 Use With a Pfeiffer Vacuum Measurement Unit

If the gauge is used with a Pfeiffer Vacuum measurement unit for Compact Gauges, a corresponding connection cable is required (→ 22).

- Secure the connector on the gauge with the screw.

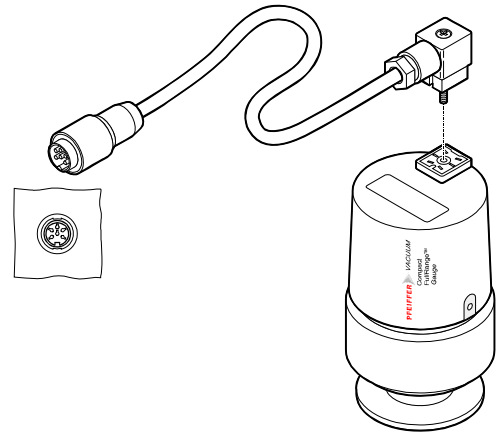

### 3.2.2 Use With Another Evaluation Unit

The gauge can also be operated with other evaluation units. In this case, an individual connection cable must be made.

For cable lengths up to 6 m (with a conductor cross-section of  $0.34 \text{ mm}^2$ ), the measuring signal can be read directly between the positive signal output (pin 2) and the supply common (pin 5) without the degree of accuracy being lowered. For longer measurement cable lengths, we recommend a differential measurement between the signal output and the signal common (pin 3) (as a result of the voltage drop along the supply cable ground lead, the common mode signal is approx. 1.0 V at the maximum admissible cable length).

#### Procedure

- 1 Prepare the connector (ordering number → 22).

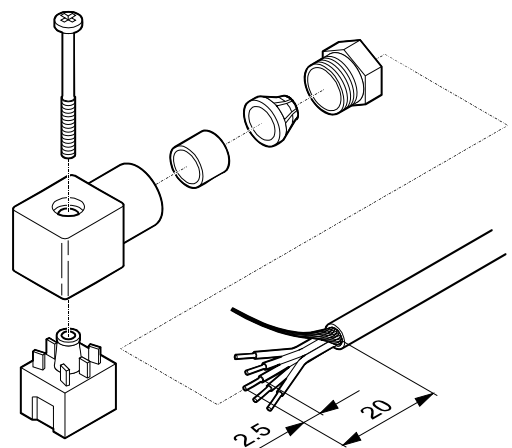

2 Solder the connection cable according to the diagram.

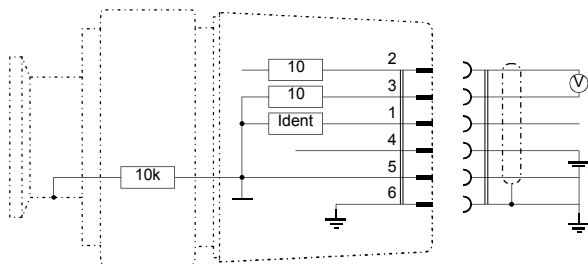
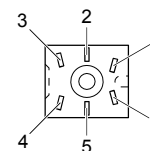

Figure 1: Electrical connection

- Pin 1 identification
- Pin 2 signal output (measuring signal)
- Pin 3 signal common
- Pin 4 supply
- Pin 5 supply common
- Pin 6 screen



Connector, soldering side

**WARNING**

The supply common (pin 5) and the screen (pin 6) must be connected to the supply unit with protective ground. Incorrect connection, incorrect polarity, or inadmissible supply voltages can damage the gauge.

3 Reassemble the connector.

4 Plug in the connector.  
Secure the connector on the gauge with the screw.

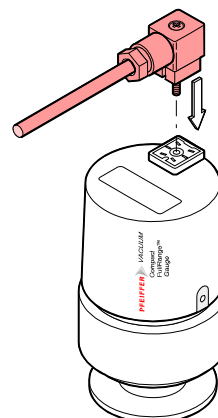

## 4 Operation

As soon as the required voltage is applied, the measuring signal is available between pins 2 and 3. (→ Appendix A for the relationship between the measuring signal and the pressure).

Allow for a stabilizing time of approx. 10 min. Once the gauge has been switched on, permanently leave it on irrespective of the pressure.

### 4.1 Measurement Principle, Measuring Behavior

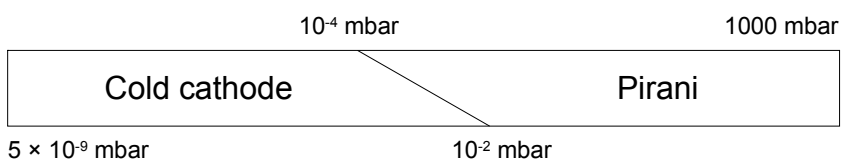

The PKR 251 consists of two separate measurement systems (Pirani and cold cathode system according to the inverted magnetron principle). They are combined in such a way that for the user, they behave as one single measurement system.

The optimum measurement configuration for the particular pressure range, in which measurement is performed, is used:



- The Pirani measurement circuit is always on.
- The cold cathode measurement circuit is controlled by the Pirani circuit and is activated only at pressures  $< 1 \times 10^{-2}$  mbar.

The identification output (pin 1) indicates the current status of the gauge:

Pressure	Green lamp on the gauge	Operating mode	Identification
$p > 1 \times 10^{-2}$ mbar		Pirani-only mode	11.1 kΩ (Pirani)
$p < 1 \times 10^{-2}$ mbar		Pirani-only mode (cold cathode measurement circuit not ignited)	11.1 kΩ (Pirani)
		Combined operation	9.1 kΩ (combined)

As long as the cold cathode measurement circuit has not ignited, the measurement value of the Pirani is output as measuring signal (if  $p < 5 \times 10^{-4}$  mbar, "Pirani underrange" is displayed).

#### Gas type dependence

The measuring signal depends on the type of gas being measured. The curves are accurate for N<sub>2</sub>, O<sub>2</sub>, dry air and CO. They can be mathematically converted for other gases (→ Appendix B).

If you are using a Pfeiffer Vacuum measurement unit for Compact Gauges, you can enter a calibration factor to correct the measurement value displayed (→  of that measurement unit).

#### Ignition delay

When cold cathode measurement systems are activated, an ignition delay occurs. The delay time increases at low pressures and is typically:

- $10^{-5}$  mbar  $\approx$  1 second
- $10^{-7}$  mbar  $\approx$  20 seconds
- $5 \times 10^{-9}$  mbar  $\approx$  2 minutes

As long as the cold cathode measurement circuit has not yet ignited, the measurement value of the Pirani is output as measuring signal ("Pirani underrange" is displayed for pressures  $<5 \times 10^{-4}$  mbar). The identification output (pin 1) indicates the Pirani-only mode.

**Caution**

If the gauge is activated at a pressure  $p < 3 \times 10^{-9}$ , the gauge cannot recognize whether the cold cathode system has ignited. It indicates "Pirani-Underrange".

**Caution**

Once flanged on, permanently leave the PKR 251 gauge in the operating mode irrespective of the pressure range. Like this, the ignition delay of the cold cathode measurement circuit is always negligible ( $<1$  s), and thermal stabilizing effects are minimized.

## Contamination

Gauge failures due to contamination or wear and tear, as well as expendable parts (e.g. filament), are not covered by the warranty.

Gauge contamination is influenced by the process media used as well as any present or new contaminants and their respective partial pressures. Continuous operation in the range of  $10^{-4}$  mbar ...  $10^{-2}$  mbar can cause severe contamination as well as reduced up-time and maintenance cycles. With constantly low pressures ( $p < 1 \times 10^{-6}$  mbar), the gauge can be operated for more than one year without cleaning (cleaning the gauge → 18).

Contamination of the gauge generally causes a deviation of the measured values:

- In the high pressure range ( $1 \times 10^{-3}$  mbar ... 0.1 mbar), the pressure indication is too high (contamination of the Pirani element). Readjustment of the Pirani measurement system → 15.
- In the low pressure range ( $p < 1 \times 10^{-3}$  mbar), the pressure indication is usually too low (contamination of the cold cathode system). In case of severe contamination, instabilities can occur (layers of the measuring chamber peel off). Contamination due to insulation layers can even lead to a complete failure of the discharge ("Underrange" is displayed).

Contamination can to a certain extent be reduced by:

- geometric protection measures (e.g. screenings, elbows) for particles that spread rectilinearly
- mounting the flange of the gauge at a place where the partial pressure of the pollutants is particularly low.

Special precautions are required for vapors deposited under plasma (of the cold cathode measurement system). It may even be necessary to temporarily switch off the gauge while vapors occur.

## 5 Maintenance

Gauge failures due to contamination or wear and tear, as well as expendable parts (e.g. filament), are not covered by the warranty.

**DANGER**

**DANGER: contaminated parts**  
 Contaminated parts can be detrimental to health and environment. Before you begin to work, find out whether any parts are contaminated. Adhere to the relevant regulations and take the necessary precautions when handling contaminated parts.

### 5.1 Adjusting the Gauge

The gauge is factory-calibrated. Readjusting the gauge can become necessary due to use under different climatic conditions, aging, or contamination (→ 14).

The cold cathode measurement circuit, which is dominant for low pressures ( $<1 \times 10^{-3}$  mbar), is factory-calibrated and cannot be adjusted. By way of contrast, the Pirani measurement circuit can be adjusted. Any adjustment has a negligible effect on the pressure range between approx.  $10^{-2}$  mbar and  $10^2$  mbar.

#### Tools required

- Screw driver No. 0
- Cylindrical pin  $\varnothing \approx 3$  mm

#### Procedure

- 1** Put the gauge into operation (if possible, in the position, in which it will be used later on).
- 2** Evacuate the vacuum system to  $p \ll 10^{-4}$  mbar, and then wait 10 minutes.
- 3** Turn the nameplate counter-clockwise until the mechanical stop is reached.

**4**

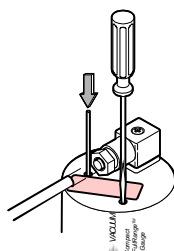

While depressing the pin with the cylindrical pin, adjust the <HV> potentiometer

... to  $5 \times 10^{-4}$  mbar      or      ... to 4.2 V.

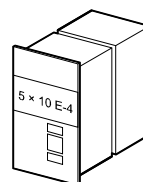

Then turn the potentiometer counter-clockwise by 1/3.

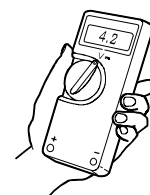

- 5 Vent with air or nitrogen to atmospheric pressure and then wait 10 minutes.
- 6 Turn the nameplate clockwise until the mechanical stop is reached.

7

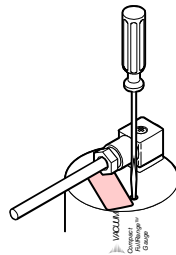

Adjust the <ATM> potentiometer ...  
... to  $1 \times 10^3$  mbar or ... to 8.6 V

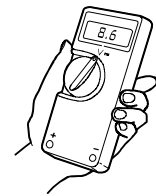
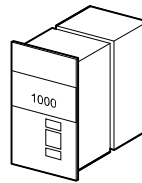

- 8 Turn the nameplate back to its original position (it will catch).

## 5.2 Cleaning the Gauge / Replacing Parts

**DANGER**

**DANGER: cleaning agents**  
Cleaning agents can be detrimental to health and environment. Adhere to the relevant regulations and take the necessary precautions when handling and disposing of cleaning agents. Consider possible reactions with the product materials (→ 8).

**Caution**

We recommend to replace the Pirani element when cleaning the gauge.

### Tools / material required

- Allen wrench AF 1.5
- Allen wrench AF 3
- Open-end wrench AF 7
- Pliers for circlip
- Polishing cloth (400 grain) or Scotch-Brite
- Tweezers
- Cleaning alcohol
- Mounting tool for ignition aid
- Ignition aid
- Pirani element (13) incl. FPM seal (13a)
- FPM seal (11) for anode feedthrough



## 5.2.1 Disassembling the Gauge

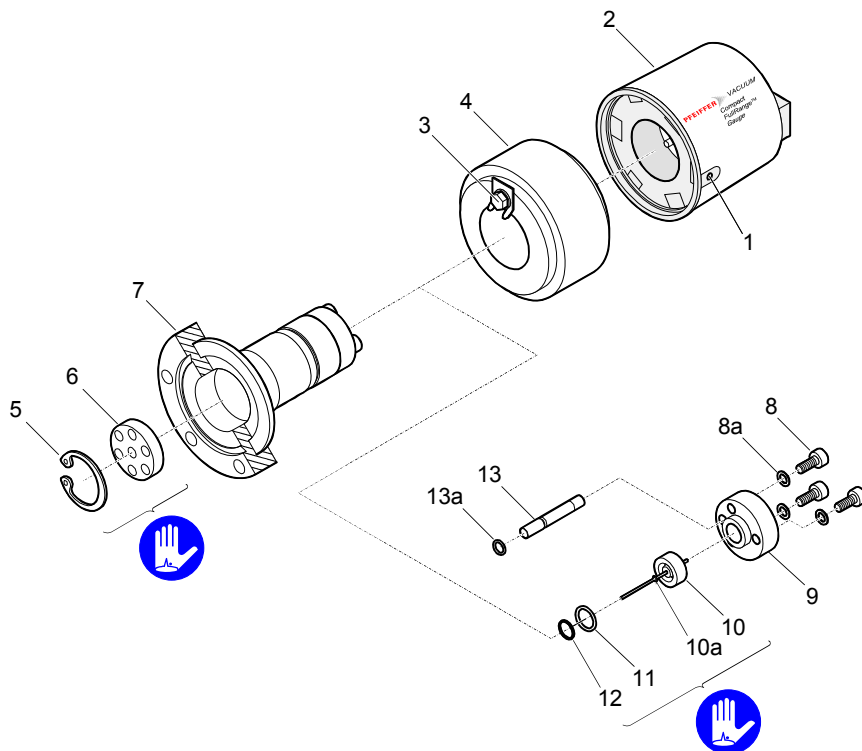

Figure 2

### Procedure

- ➊ Remove the gauge from the vacuum system (→ 21).
- ➋ Unfasten the hexagon socket set screw (1) on the side of the electronics unit (2) (→ Figure 2).
- ➌ Remove the electronics unit **without twisting it**.



#### Caution



The cover of the electronics unit cannot be removed.

- ➍ Unfasten the hexagon head screw (3) on the magnet unit (4) and remove the magnet unit.



#### Caution



The magnetic force and the tendency to tilt make it more difficult to separate the magnet unit and the measuring chamber (7).

- ➎ Remove the circlip (5) and the polarity insert (6) from the measuring chamber.
- ➏ Remove the three hexagon socket screws (8) incl. lock washers (8a) on the back of the measuring chamber.

- 7 Carefully remove the following parts in this order (without exerting stress on the Pirani element (13)): pressure piece (9), complete anode (10), FPM seal (11) incl. support ring (12), Pirani element (13) incl. FPM seal (13a).

The parts can now be cleaned or replaced individually.

## 5.2.2 Cleaning the Gauge

### Procedure

Cleaning the measuring chamber and the polarity insert:

- 1 Using a polishing cloth rub the inside walls of the measuring chamber and the polarity insert to a bright finish.

**Caution**

The sealing surfaces must only be worked concentrically.

- 2 Rinse the measuring chamber and the polarity insert with cleaning alcohol.
- 3 Allow both to dry.

Cleaning or replacing the anode:

- 1 Remove the old ignition aid (10a), for example with tweezers (→ Figure 2).
- 2 Using a polishing cloth rub the anode pin to a bright finish.

**Caution**

Do not bend the anode. Do not carry out mechanical work on the ceramic part.

- 3 Rinse the anode with cleaning alcohol.
- 4 Allow the anode to dry.
- 5 Insert a new ignition aid (10a) into the mounting tool.
- 6 Carefully press the anode (clean or new) centered and parallel to the tool axis into the ignition aid and insert it to a depth of approx. 15 mm. The final positioning is established after the anode is installed.

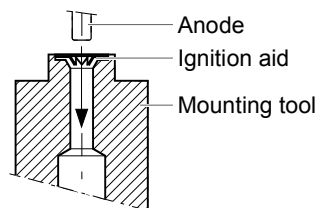

Cleaning the Pirani element:

- 1 Remove the FPM seal (13a) from the Pirani element (13).

- ② Fill the Pirani measuring tube with cleaning alcohol and let it work.
- ③ Pour the alcohol out of the tube.
- ④ Dry the tube (e.g. with a blow dryer <math><150^{\circ}\text{C}</math>).
- ⑤ Slide a new FPM seal over the Pirani element and insert it into the corresponding groove.
- ⑥ Remount the Pirani element (→ section 5.2.3).

Replacing the Pirani measurement element:

(If it is severely contaminated or defective)

- ① Slide a new FPM seal (13a) over the Pirani element (13) and insert it into the corresponding groove.
- ② Mount the Pirani element (→ section 5.2.3).

### 5.2.3 Reassembling the Gauge

#### Procedure

- ① Insert the FPM seal (11) with the support ring (12) centered into the measuring chamber (7). The sealing surface, seal, and ceramic part must be clean (→ Figure 2).
- ② Carefully insert the anode (10) incl. ignition aid (10a) into the measuring chamber.
- ③ Insert the Pirani element (13) with the FPM seal (13a) slid over it into the corresponding bore hole.
- ④ Carefully place the pressure piece (9) on the measuring chamber and tighten them with the three hexagon socket screws (8) incl. lock washers (8a) uniformly until the stop position is reached.
- ⑤ Position the ignition aid (10a) by pushing the mounting tool over the anode pin until the mechanical stop is reached.
- ⑥ Blow the particles in the measuring chamber with dry nitrogen (be careful to hold the measuring chamber with the flange pointing downwards).
- ⑦ Slide the polarity insert (6) into the measuring chamber until the mechanical stop is reached.
- ⑧ Place the circlip (5) snugly fitting on the polarity insert.



#### Caution



Visually check that the anode pin is centered over the middle hole of the polarity insert (max. eccentricity = 0.5 mm).

- 9 If possible perform a leak test (leak rate  $<10^{-9}$  mbar l/s).

**WARNING**

WARNING: electric arcing  
Helium may cause electric arcing with detrimental effects on the electronics of the product.  
Before performing any tightness tests put the product out of operation and remove the electronics unit.

- 10 Mount the magnet unit (4) and lock it with the screw (3).
- 11 Carefully mount the electronics unit (2). (Make sure the pin of the Pirani element is properly plugged into the corresponding hole of the electronics unit.)
- 12 Push the electronics unit up to the mechanical stop and lock it with the hexagon socket set screw (1).

**DANGER**

Due to missing ground connection in conjunction with missing or not correctly tightened hexagon socket set screw (1) dangerous contact voltage will occur.

- 13 Adjust the gauge (→ 15).

### 5.3 What to Do in Case of Problems

Problem	Possible cause	Remedy
Measuring signal continually $< 0.5$ V "Error low".	No supply voltage.	Turn on the power supply.
Measuring signal continually $> 9.5$ V "Error high".	Pirani measurement element defective (filament rupture).	Replace the Pirani element (→ 18).
	Electronics unit not correctly mounted.	Mount the electronics unit correctly (→ 19).
The green lamp is ON and the identification indicates Pirani-only mode (measuring signal continually $> 4.0$ V) "Pirani underrange".	The cold cathode discharge has not ignited.	Wait until the gas discharge ignites (in case of contamination with insulation layers, the cold cathode may completely fail to ignite). (Cleaning → 18).
	The PKR has only been activated with $p < 3 \times 10^{-9}$ mbar	Slightly increase the pressure.
Measuring signal continually $> 5$ V or display $> 10^{-3}$ mbar although vacuum pressure is OK.	Pirani measurement circuit not adjusted, e.g. due to severe contamination.	Readjust the Pirani measurement circuit (→ 15). If adjustment is impossible, replace the Pirani element.
	Measurement of heavy gases.	Convert with the corresponding formula (→ 26).
	Severe outgassing in the measuring chamber.	Clean the measuring chamber.
Measuring signal unstable.	Gauge contaminated.	Clean the gauge (→ 18).

## 6 Removing the Gauge From the Vacuum System

### DANGER



**DANGER: contaminated parts**  
Contaminated parts can be detrimental to health and environment. Before you begin to work, find out whether any parts are contaminated. Adhere to the relevant regulations and take the necessary precautions when handling contaminated parts.

### Caution



**Caution: vacuum component**  
Dirt and damages impair the function of the vacuum component. When handling vacuum components, take appropriate measures to ensure cleanliness and prevent damages.

### Procedure

**1** Deactivate the gauge.

**2** Unplug the connector.

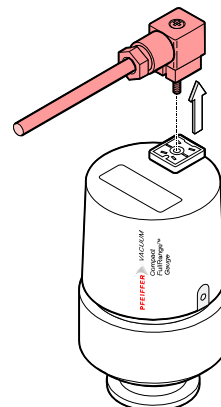

**3** Remove the gauge from the vacuum system.

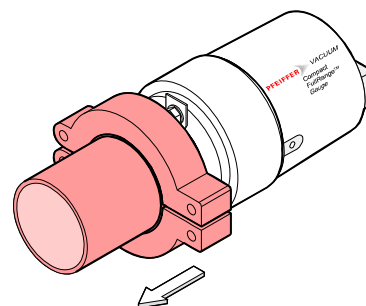

**4** Place the protective cap.

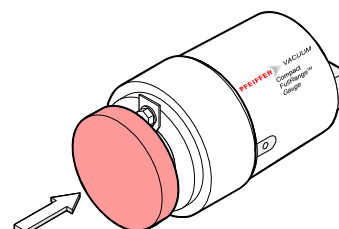

## 7 Returning the Product

**WARNING**

**WARNING: forwarding contaminated products**

Products returned to Pfeiffer Vacuum for service or repair should, if possible, be free of harmful substances (e.g. radioactive, toxic, caustic or microbiological). Otherwise, the type of contamination must be declared.

Adhere to the forwarding regulations of all involved countries and forwarding companies and enclose a completed contamination declaration<sup>\*)</sup>.

<sup>\*)</sup> Form under [www.pfeiffer-vacuum.net](http://www.pfeiffer-vacuum.net)

Products that are not clearly declared as "free of harmful substances" are decontaminated at the expense of the customer.

## 8 Accessories

	Ordering number
Connection cable for Pfeiffer Vacuum measurement unit for Compact Gauges	
3 m	PT 448 250-T
6 m	PT 448 251-T
10 m	PT 448 252-T
Connection socket Hirschmann	B 4707 283 MA
GO 6 WF 6 contacts, angled, female	
Magnetic shielding	PT 443 155-X

## 9 Spare Parts

When ordering spare parts, always indicate:

- the type of product
- the manufacturing number given on the product nameplate
- the position, description, and ordering number according to the spare parts list

The following parts are available as spare parts sets:

Pos.	Description	Ordering number
12	Maintenance set, consisting of:	BN 846 239-T
	1× support ring	
13a	1× O-ring FPM 3.69 × 1.78	
11	1× O-ring FPM 10.82 × 1.78	
10a	3× ignition aid	
13	Repair set, consisting of:	BN 846 238-T
12	1× Pirani measurement element, cpl.	
12	1× support ring	
13a	1× O-ring FPM 3.69 × 1.78	
11	1× O-ring FPM 10.82 × 1.78	
10a	3× ignition aid	
10	1× anode, complete	
10a	Set of ignition aids, consisting of:	BN 845 995-T
	10× ignition aid	
	Mounting tool for ignition aid	BG 510 600
2	Electronics unit PKR 251	PT 120 140-T
	Measuring system, complete	
	DN 25 ISO-KF flange	BN 846 469-T
	DN 40 ISO-KF flange	BN 846 470-T
	DN 40 CF-F flange	BN 846 471-T
	Exchange gauge (return defective gauge to Pfeiffer Vacuum)	
	DN 25 ISO-KF flange	PT R26 000-A
	DN 40 ISO-KF flange	PT R26 001-A
	DN 40 CF-F flange	PT R26 002-A

## 10 Disposal



### WARNING



WARNING: substances detrimental to the environment  
Products, operating materials etc. may have to be specially disposed of.

For environmentally compatible disposal, please contact your nearest Pfeiffer Vacuum Service Center.

# Appendix

## A: Measuring Signal vs. Pressure

Conversion formulae

$$p = 10^{1.667 \times U - d} \Leftrightarrow U = c + 0.6 \times \log_{10} p$$

p	U	c	d
[mbar]	[V]	6.8	11.33
[µbar]	[V]	5.0	8.333
[Torr]	[V]	6.875	11.46
[mTorr]	[V]	5.075	8.458
[micron]	[V]	5.075	8.458
[Pa]	[V]	5.6	9.333
[kPa]	[V]	7.4	12.33

where U measuring signal      valid in the range       $5 \times 10^{-9}$  mbar < p < 1000 mbar  
 p pressure                               $3.8 \times 10^{-9}$  Torr < p < 750 Torr  
 c, d constant (pressure               $5 \times 10^{-7}$  Pa < p <  $1 \times 10^5$  Pa  
 unit dependent)

Conversion curves

Pressure p

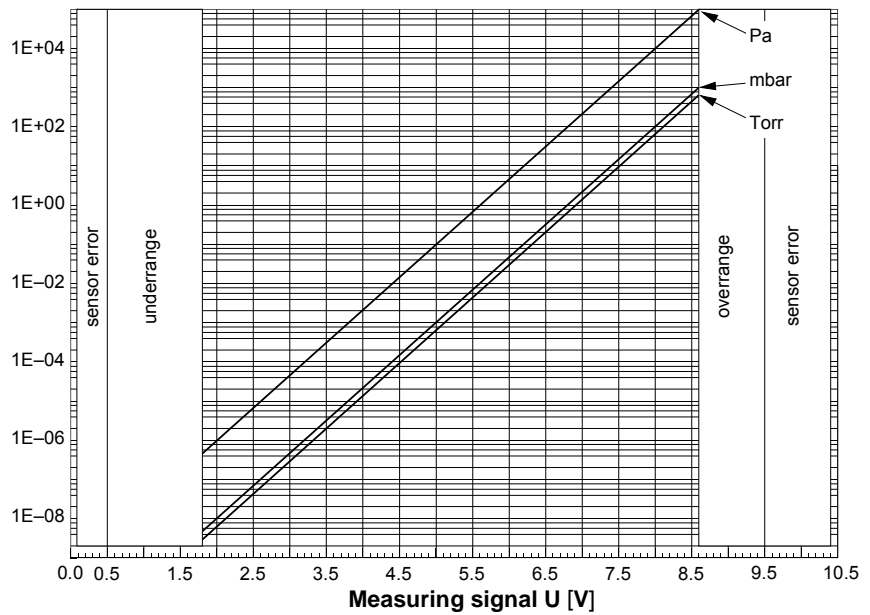



Conversion table

Measuring signal U [V]	[mbar]	Pressure p [Torr]	[Pa]
< 0.5		Sensor error	
0.5 ... 1.82		Underrange	
1.82	$5.0 \times 10^{-9}$	$3.8 \times 10^{-9}$	$5.0 \times 10^{-7}$
2.0	$1.0 \times 10^{-8}$	$7.5 \times 10^{-9}$	$1.0 \times 10^{-6}$
2.6	$1.0 \times 10^{-7}$	$7.5 \times 10^{-8}$	$1.0 \times 10^{-5}$
3.2	$1.0 \times 10^{-6}$	$7.5 \times 10^{-7}$	$1.0 \times 10^{-4}$
3.8	$1.0 \times 10^{-5}$	$7.5 \times 10^{-6}$	$1.0 \times 10^{-3}$
4.4	$1.0 \times 10^{-4}$	$7.5 \times 10^{-5}$	$1.0 \times 10^{-2}$
5.0	$1.0 \times 10^{-3}$	$7.5 \times 10^{-4}$	0.1
5.6	$1.0 \times 10^{-2}$	$7.5 \times 10^{-3}$	1.0
6.2	0.1	$7.5 \times 10^{-4}$	10
6.8	1.0	0.75	100
7.4	10	7.5	1000
8.0	100	75	$1.0 \times 10^4$
8.6	1000	750	$1.0 \times 10^5$
8.6 ... 9.5		Overrange	
9.5 ... 10.5		Sensor error (Pirani defective)	

## B: Gas Type Dependence

Indication range above  
 $10^{-2}$  mbar  
 (Pirani only mode)

Pressure indicated (gauge calibrated for air)

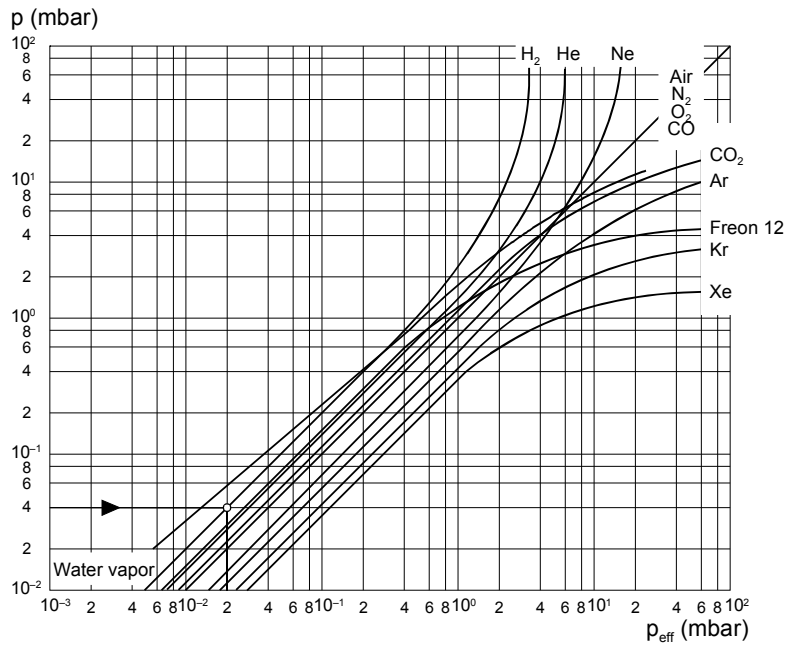

Indication range  
 $10^{-6}$  ... 0.1 mbar

Pressure indicated (gauge calibrated for air)

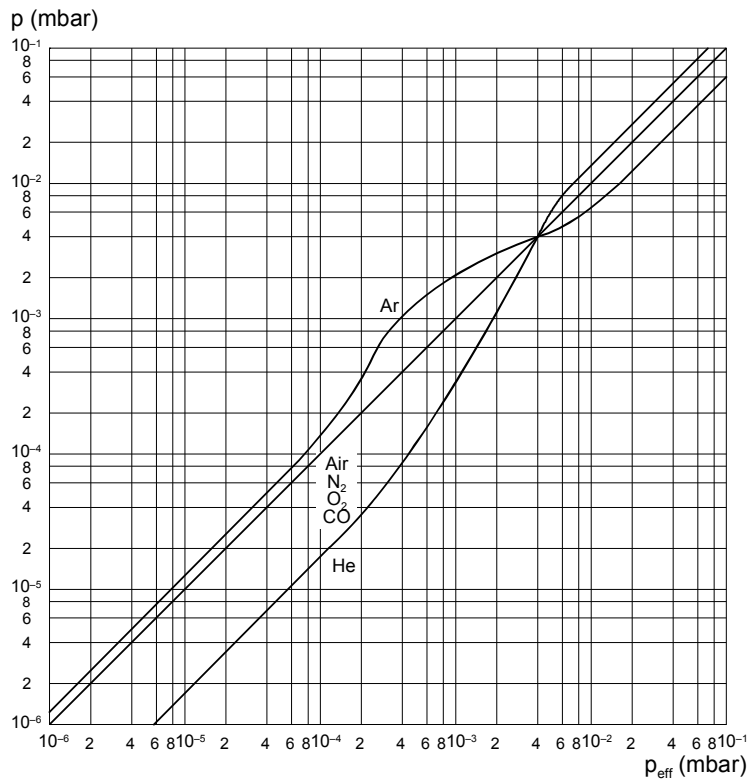

Indication range below  
 $4 \times 10^{-5}$  mbar

In the range below  $10^{-5}$  mbar, the pressure indication is linear. For gases other than air, the pressure can be determined by means of a simple conversion formula:

$$p_{\text{eff}} = K \times \text{pressure indicated}$$

where	gas type	K
	air (N <sub>2</sub> , O <sub>2</sub> , CO)	1.0
	Xe	0.4
	Kr	0.5
	Ar	0.8
	H <sub>2</sub>	2.4
	Ne	4.1
	He	5.9

These conversion factors are average values.



### Caution



A mixture of gases and vapors is often involved. In this case, accurate determination is only possible with a partial pressure measurement instrument, e.g. a quadrupole mass spectrometer.

**Leading. Dependable.  
Customer Friendly.**

Pfeiffer Vacuum stands for innovative and custom vacuum solutions worldwide. For German engineering art, competent advice and reliable services.

Ever since the invention of the turbopump, we've been setting standards in our industry. And this claim to leadership will continue to drive us in the future.

**You are looking for a  
perfect vacuum solution?  
Please contact us:**

**Germany**  
Pfeiffer Vacuum GmbH  
Headquarters  
Tel.: +49 (0) 6441 802-0  
info@pfeiffer-vacuum.de

**Great Britain**  
Pfeiffer Vacuum Ltd.  
Tel.: +44 1908 500600  
sales@pfeiffer-vacuum.co.uk

**Austria**  
Pfeiffer Vacuum Austria GmbH  
Tel.: +43 1 894 17 04  
office@pfeiffer-vacuum.at

**Benelux**  
Pfeiffer Vacuum GmbH  
Sales & Service Benelux  
Tel.: +800-pfeiffer  
benelux@pfeiffer-vacuum.de

**India**  
Pfeiffer Vacuum India Ltd.  
Tel.: +91 40 2775 0014  
pfeiffer@vsnl.net

**Sweden**  
Pfeiffer Vacuum Scandinavia AB  
Tel.: +46 8 590 748 10  
sales@pfeiffer-vacuum.se

**China**  
Pfeiffer Vacuum  
(Shanghai) Co., Ltd.  
Tel.: +86 21 3393 3940  
info@pfeiffer-vacuum.cn

**Italy**  
Pfeiffer Vacuum Italia S.p.A.  
Tel.: +39 02 93 99 05 1  
contact@pfeiffer-vacuum.it

**Switzerland**  
Pfeiffer Vacuum (Schweiz) AG  
Tel.: +41 44 444 22 55  
info@pfeiffer-vacuum.ch

**France**  
Pfeiffer Vacuum France SAS  
Tel.: +33 169 30 92 82  
info@pfeiffer-vacuum.fr

**Korea**  
Pfeiffer Vacuum Korea Ltd.  
Tel.: +82 31 266 0741  
sales@pfeiffer-vacuum.co.kr

**United States**  
Pfeiffer Vacuum Inc.  
Tel.: +1 603 578 6500  
contact@pfeiffer-vacuum.com

