

Introduction to the tokamak GOLEM operation Practical guide

Vojtěch Svoboda
on behalf of the tokamak GOLEM team
for the Fusion-EP

March 7, 2024

Table of Contents

- 1 Introduction
- 2 The Tokamak (GOLEM)
- 3 The Tokamak GOLEM (remote) operation
- 4 The Electron energy confinement time calculation (rough estimation)
- 5 Conclusion
- 6 Appendix

Milestones to Fusion Power Plant

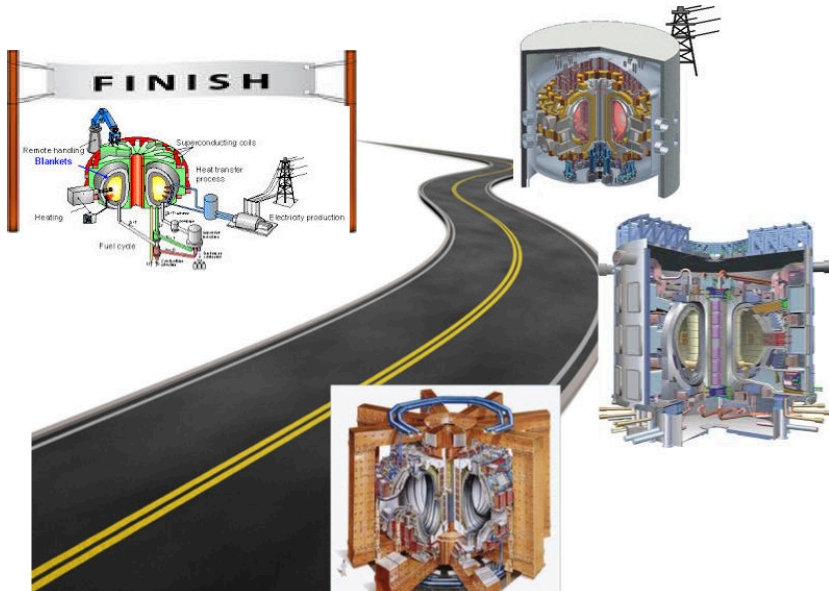

Education importance



Let's start with the tokamak GOLEM - *the smallest tokamak in the World with the biggest control room*

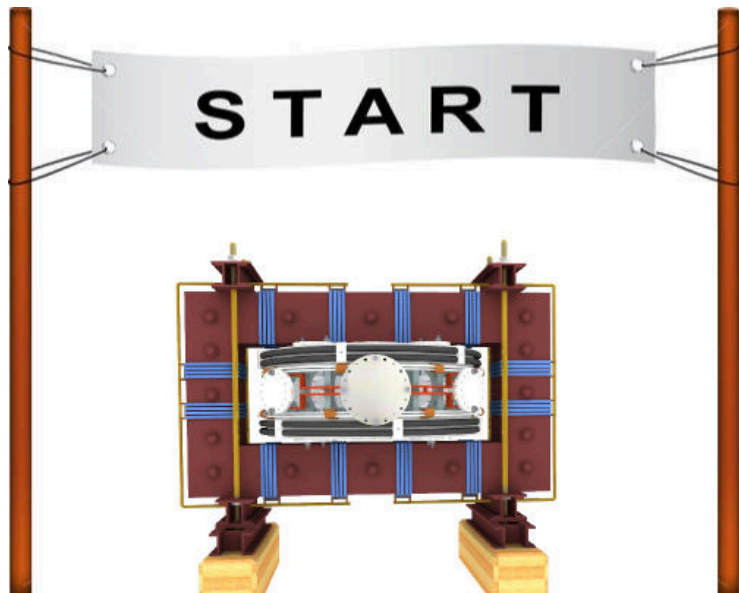

The GOLEM tokamak basic characteristics

The grandfather of all tokamaks (ITER newslines 06/18)

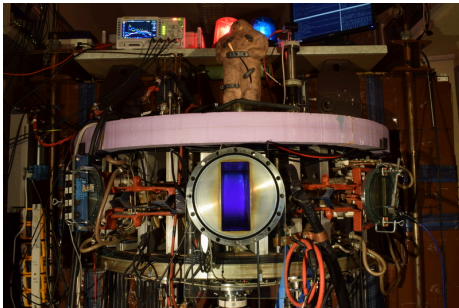

- Vessel major radius: $R_0 = 0.4$ m
- Vessel minor radius: $r_0 = 0.1$ m
- Maximum plasma current:
 $I_p^{\max} < 8$ kA
- Maximum toroidal magnetic field: $B_t^{\max} < 0.5$ T
- Typical electron density:
 $\langle n_e \rangle \in (0.2, 3) \cdot 10^{19} \text{ m}^{-3}$
- Maximum electron temperature:
 $T_e^{\max} < 80$ eV
- Maximum discharge duration:
 $\tau_p^{\max} < 25$ ms

Tokamak GOLEM @ Wikipedia ..

File Edit View Go Bookmarks Tools Settings Window Help

W https://en.wikipedia.org/wiki/Tokamak

home Kalendarj Produkce Forecast Slovník Ráno

Not logged in [Talk](#) [Contributions](#) [Create account](#) [Log in](#)

Article [Talk](#) [Read](#) [Edit](#) [View history](#)

 **WIKIPEDIA**
The Free Encyclopedia

[Main page](#)
[Contents](#)
[Featured content](#)
[Current events](#)

Tokamak

From Wikipedia, the free encyclopedia

This article is about the fusion reaction device. For other uses, see [Tokamak \(disambiguation\)](#).

A **tokamak** (Russian: **токамак**) is a device that uses a powerful magnetic field to confine plasma in the shape of a torus. Achieving a stable plasma equilibrium requires magnetic field lines that wrap around the torus in a helical shape. Such a helical field can be generated by adding a toroidal field

it decays into a proton and electron with the emission of energy. When the time comes to actually try to make electricity from a tokamak-based reactor, some of the neutrons produced in the fusion process would be absorbed by a liquid metal blanket and their kinetic energy would be used in heat-transfer processes to ultimately turn a generator.

Experimental tokamaks [[edit](#)]

Currently in operation [[edit](#)]

(in chronological order of start of operations)

- 1960s: TM1-MH (since 1977 Castor; since 2007 Golem^[122]) in Prague, Czech Republic. In operation in Kurchatov Institute since early 1960s but renamed to Castor in 1977 and moved to IPP CAS,^[131] Prague; in 2007 moved to FNSPE, Czech Technical University in Prague and renamed to Golem.^[14]
- 1975: T-10, in Kurchatov Institute, Moscow, Russia (formerly Soviet Union); 2 MW
- 1983: Joint European Torus (JET), in Culham, United Kingdom
- 1985: JT-60, in Naka, Ibaraki Prefecture, Japan; (Currently undergoing upgrade to Super, Advanced model)
- 1987: STOR-M, University of Saskatchewan; Canada; first demonstration of alternating current in a tokamak.
- 1988: Tore Supra,^[151] at the CEA, Cadarache, France
- 1989: Aditya, at Institute for Plasma Research (IPR) in Gujarat, India
- 1980s: DIII-D,^[16] in San Diego, USA; operated by General Atomics since the late 1980s
- 1989: COMPASS,^[133] in Prague, Czech Republic; in operation since 2008, previously operated from 1989 to 1999 in Culham, United Kingdom
- 1990: FTU, in Frascati, Italy
- 1991: Tokamak ISTTOK,^[171] at the Instituto de Plasmas e Fusão Nuclear, Lisbon, Portugal;
- 1991: ASDEX Upgrade, in Garching, Germany



Alcator C-Mod



ida, the free encyclo... W Tokamak - Wikipedia, the free encyclo... [svoboda] buon@fi.cvut.cz - Kosside [Krusader] Inbox - svoboda@fi.cvut.cz - Mail

The GOLEM tokamak for education - historical background

Kurchatov Institute near Moscow,
Soviet Union
1960: **TM1-MH**

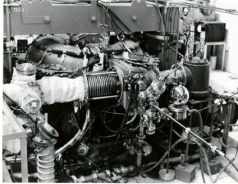

1974



Culham Centre for Fusion Energy
Great Britain
1989: **COMPASS-D**



2006



Institute of Plasma Physics
Czech republic
CASTOR **COMPASS**



2008



Czech Technical University Prague
Czech republic
GOLEM



GOLEM

... somewhere, in the ancient cellars of Prague,

there is hidden indeed "infernal" power. Yet it is the very power of celestial stars themselves. Calmly dormant, awaiting mankind to discover the magic key, to use this power for their benefit. . .



At the end of the 16th century, in the times when the Czech lands were ruled by Emperor Rudolf II, in Prague, there were Rabbi Judah Loew, well known alchemist, thinker, scholar, writer and inventor of the legendary GOLEM - a clay creature inspired with the Universe power that pursued his master's command after being brought to life with a shem, . Golem is not perceived as a symbol of evil, but rather as a symbol of power which might be useful but is very challenging to handle. To learn more of the Golem legend, see e.g. [1].

The global schematic overview of the GOLEM experiment

LEVEL 1

Tokamak technology setup

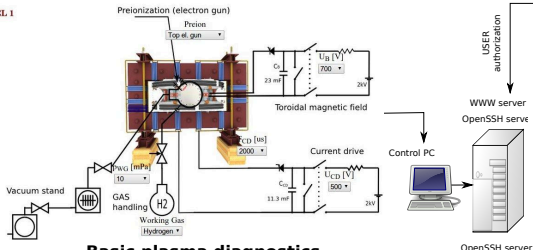

Basic plasma diagnostics

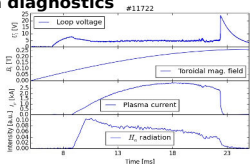
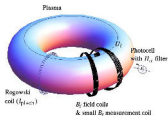

internet



**Virtual control room
(remote participation)**

WWW control interface

HTML & PHP scripts

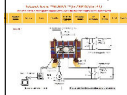

SSH control interface

WINDOWS via putty



LINUX via ssh
or ssh+X tunnel
(advanced mode)

Data presentation

HTML (www pages)

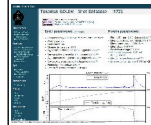

Data handling

- *wget
- *gnuplot
- *idl
- *mathematica
- *matlab
- *etc...

WWW server
OpenSSH server



OpenSSH server



Control PC

The GOLEM tokamak mission

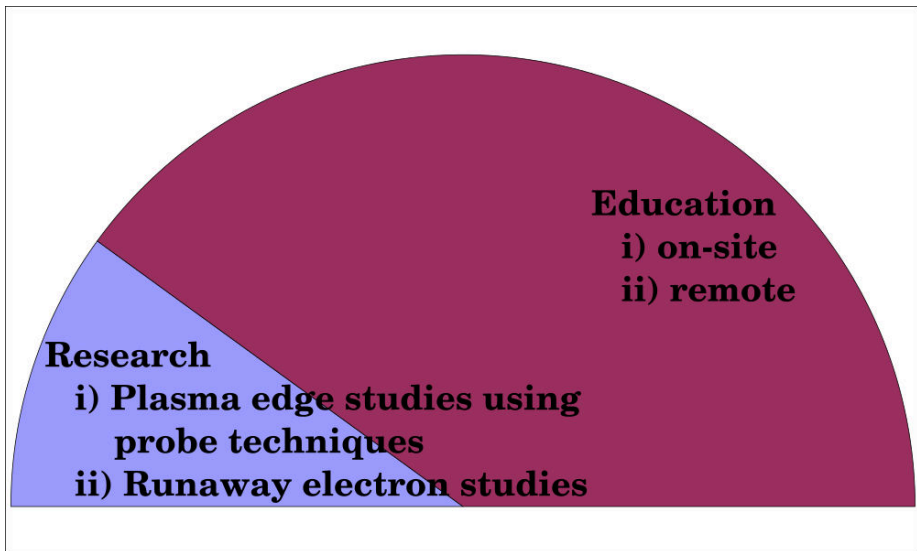

Towards ... Energy confinement time

House

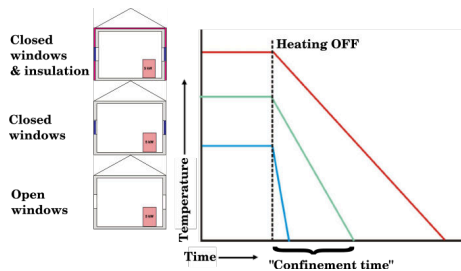

Tokamak

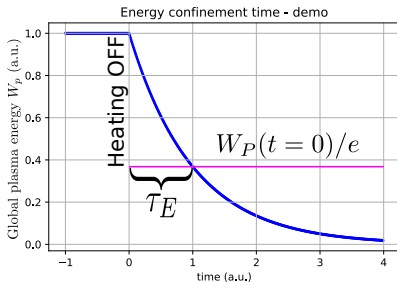

- Net power = Efficiency \times (Fusion - Radiation loss - Conduction loss)
- The confinement time: $\tau_E = \frac{W}{P_{\text{loss}}}$
- Energy density $W = 3nk_B T$ & rate of radiation and conduction energy loss per unit volume P_{loss}
- Reactions per volume per time of fusion reactions is:
 $f = n_d n_t \langle \sigma v \rangle = \frac{1}{4} n^2 \langle \sigma v \rangle$
- Fusion heating fE_{ch} , where $E_{\text{ch}} = 3.5 \text{ MeV}$ should exceed the losses:
 $fE_{\text{ch}} \geq P_{\text{loss}}$

$$n\tau_E \geq L \equiv \frac{12}{E_{\text{ch}}} \frac{k_B T}{\langle \sigma v \rangle} \geq 1.5 \cdot 10^{20} \frac{\text{s}}{\text{m}^3}$$

(DT reaction @ minimum $\approx 26 \text{ keV}$)

The competition

The ITER: 3.6 s

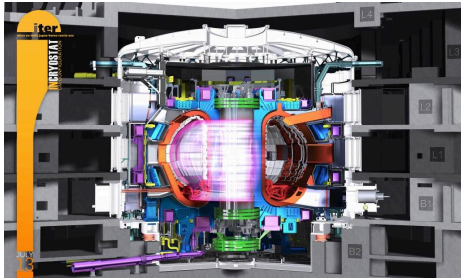

credit:[3]

The GOLEM: ??? s or ms or us ??

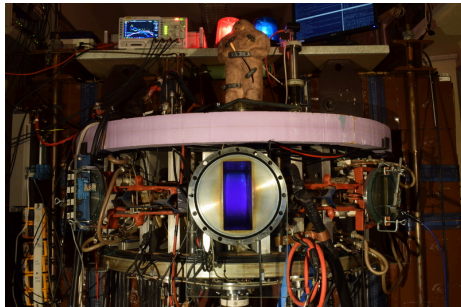

credit:[4]

- Everything via <http://golem.fjfi.cvut.cz/Cadarache>
 - This presentation
 - Control rooms
 - Contact: Vojtech Svoboda,
+420 737673903,
vojtech.svoboda@fjfi.cvut.cz
 - Videoconference:
<https://meet.google.com/hnv-qjhu-xvi>



Table of Contents

- 1 Introduction
- 2 The Tokamak (GOLEM)**
- 3 The Tokamak GOLEM (remote) operation
- 4 The Electron energy confinement time calculation (rough estimation)
- 5 Conclusion
- 6 Appendix

Tokamak magnetic confinement concept

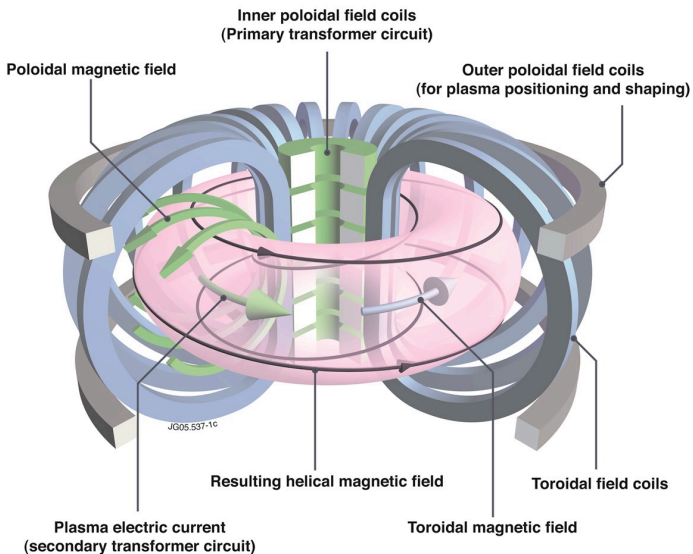

Tokamak (GOLEM) basic concept to confine and heat the plasma

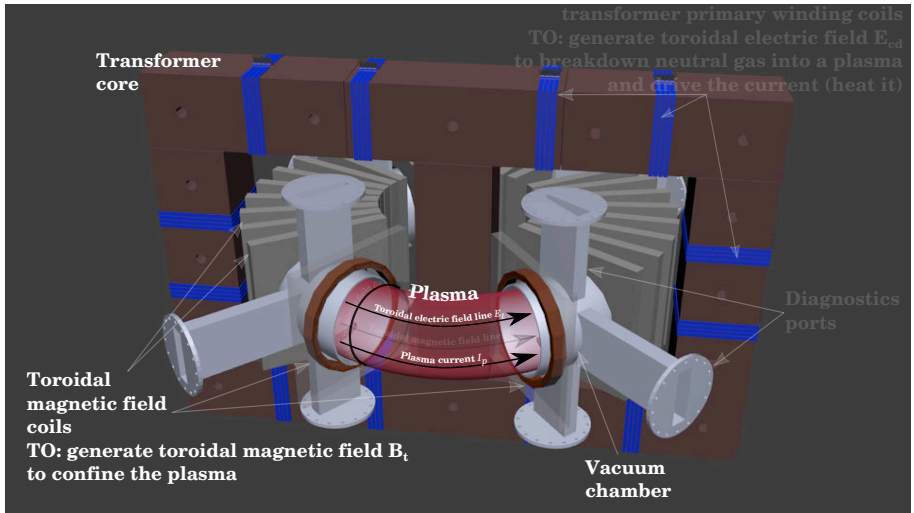

Table of Contents

1 Introduction

2 The Tokamak (GOLEM)

- The GOLEM tokamak concept
- The GOLEM tokamak - guide tour
- The scenario to make the (GOLEM) tokamak discharge
- The scenario to discharge virtually
- The GOLEM tokamak basic diagnostics

3 The Tokamak GOLEM (remote) operation

4 The Electron energy confinement time calculation (rough estimation)

5 Conclusion

Our goal: the technology to create a μ Sun on the Earth

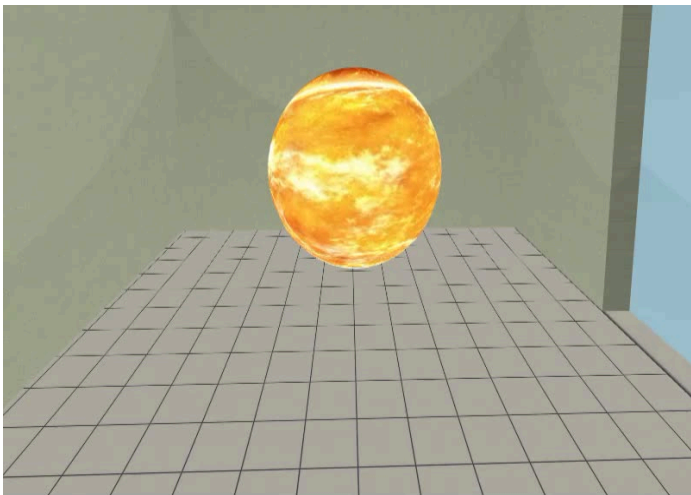

Magnetic confinement requires toroidal geometry

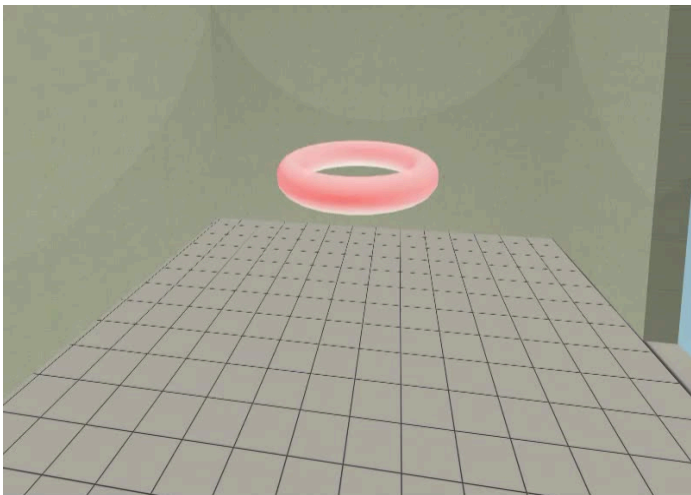

A chamber contains the thermonuclear reaction

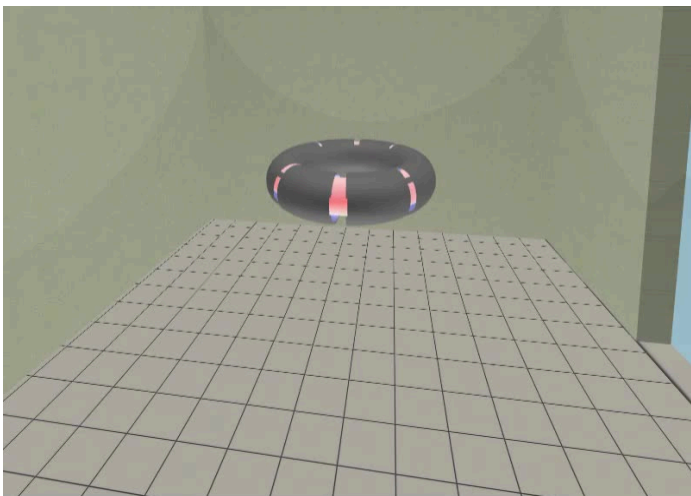

Toroidal magnetic field coils confine the plasma

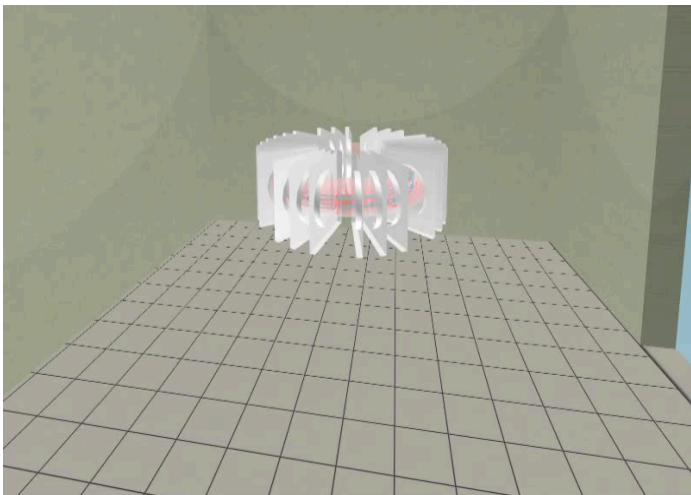

A transformer action creates and heats the plasma

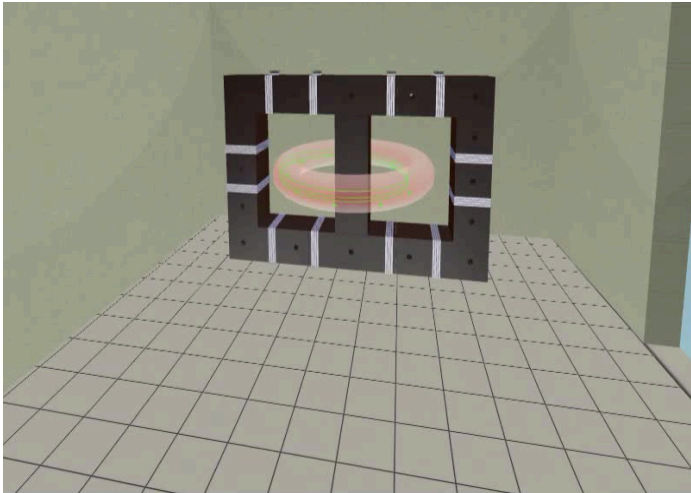

The final technology altogether

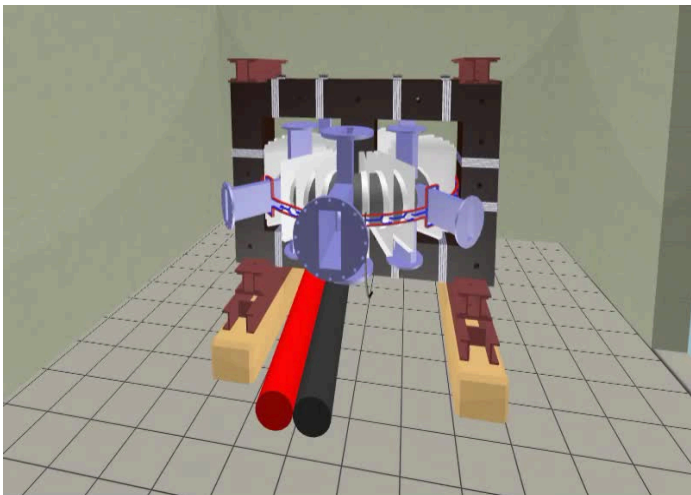

Table of Contents

1 Introduction

2 The Tokamak (GOLEM)

- The GOLEM tokamak concept
- The GOLEM tokamak - guide tour
- The scenario to make the (GOLEM) tokamak discharge
- The scenario to discharge virtually
- The GOLEM tokamak basic diagnostics

3 The Tokamak GOLEM (remote) operation

4 The Electron energy confinement time calculation (rough estimation)

5 Conclusion

Infrastructure room (below tokamak) 10/16



Infrastructure room (below tokamak) 10/16

Current drive CD field
and toroidal magnetic Bt field
circuits

To the tokamak
GOLEM

Rotary
pump

Vacuum
control

Current drive CD
capacitors

Plasma
stabilization

power
supply
2kV

Toroidal
magnetic field B
capacitors

fire
protection
system



Tokamak room (North) 10/16

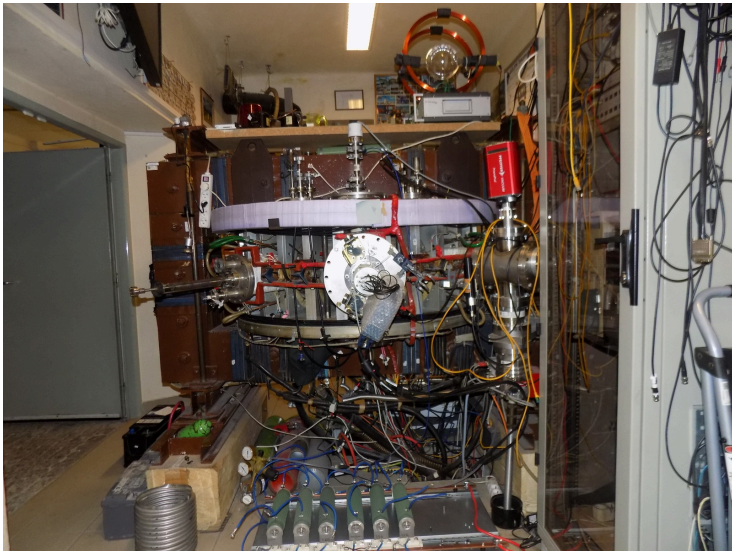

Tokamak room (North) 10/16

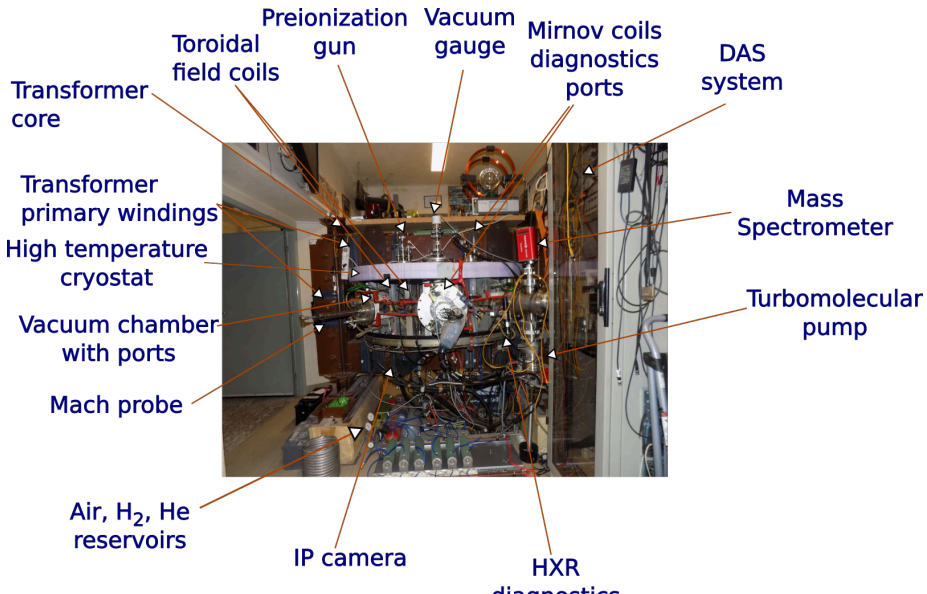

Tokamak room (South) 10/16

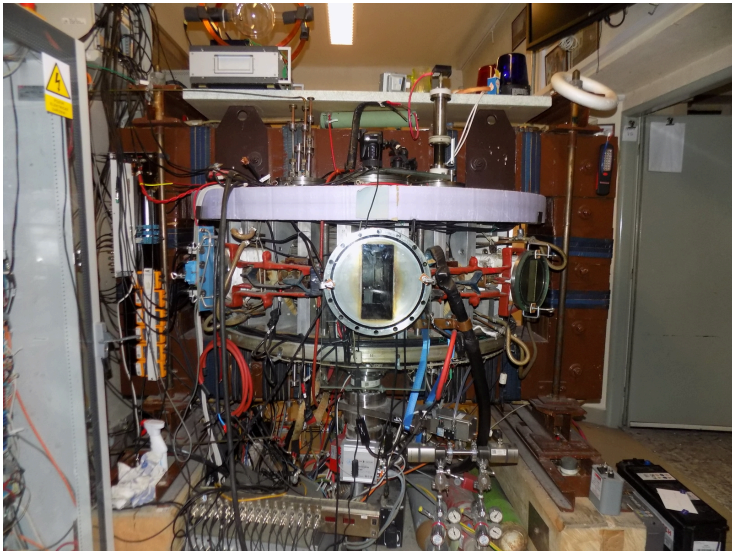

Tokamak room (South) 10/16

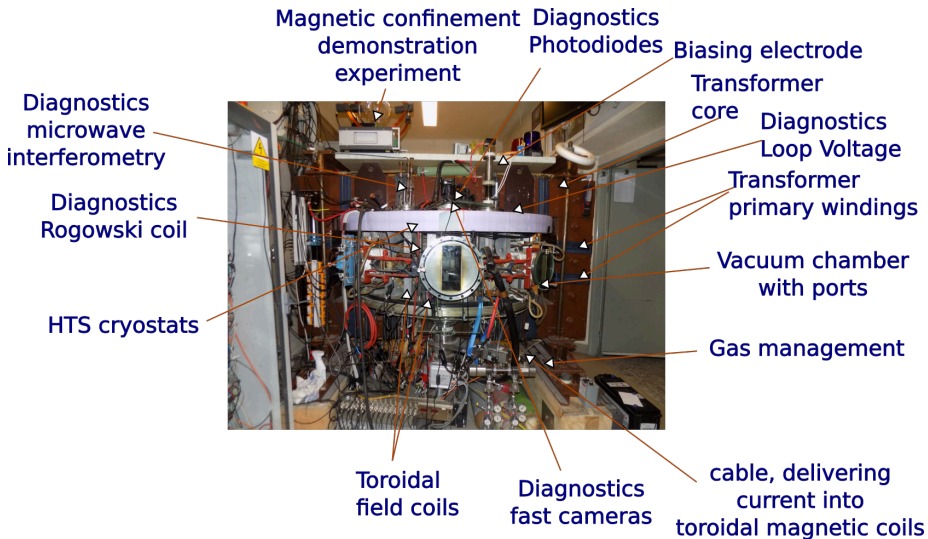

Table of Contents

1 Introduction

2 The Tokamak (GOLEM)

- The GOLEM tokamak concept
- The GOLEM tokamak - guide tour
- The scenario to make the (GOLEM) tokamak discharge
- The scenario to discharge virtually
- The GOLEM tokamak basic diagnostics

3 The Tokamak GOLEM (remote) operation

4 The Electron energy confinement time calculation (rough estimation)

5 Conclusion

Plasma in Tokamak (GOLEM) - the least to do

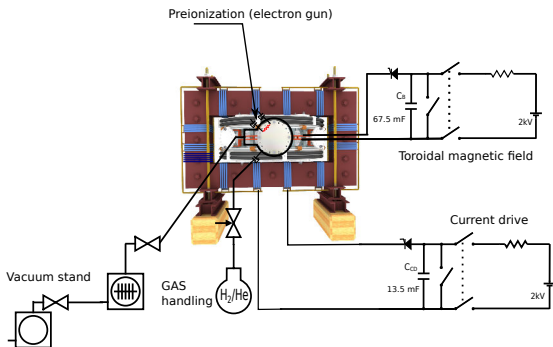

To do:

- session start phase:
 - Evacuate the chamber
- pre-discharge phase
 - Charge the capacitors
 - Fill in the working gas
 - Preionization
- discharge phase
 - Toroidal magnetic field to confine plasma
 - Toroidal electric field to breakdown neutral gas into plasma
 - Toroidal electric field to heat the plasma
 - Plasma positioning
 - Diagnostics
- post-discharge phase

Plasma in Tokamak (GOLEM) - the least to do

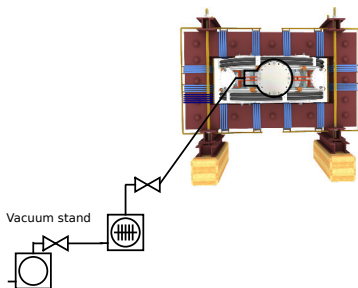

To do:

- session start phase:
 - **Evacuate the chamber**
- pre-discharge phase
 - Charge the capacitors
 - Fill in the working gas
 - Preionization
- discharge phase
 - Toroidal magnetic field to confine plasma
 - Toroidal electric field to breakdown neutral gas into plasma
 - Toroidal electric field to heat the plasma
 - Plasma positioning
 - Diagnostics
- post-discharge phase

Plasma in Tokamak (GOLEM) - the least to do

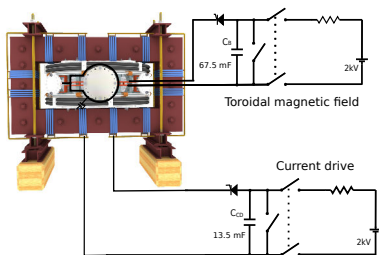

To do:

- session start phase:
 - Evacuate the chamber
- pre-discharge phase
 - **Charge the capacitors**
 - Fill in the working gas
 - Preionization
- discharge phase
 - Toroidal magnetic field to confine plasma
 - Toroidal electric field to breakdown neutral gas into plasma
 - Toroidal electric field to heat the plasma
 - Plasma positioning
 - Diagnostics
- post-discharge phase

Plasma in Tokamak (GOLEM) - the least to do

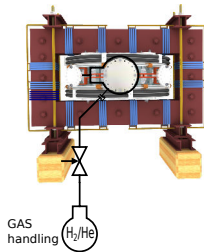

To do:

- session start phase:
 - Evacuate the chamber
- pre-discharge phase
 - Charge the capacitors
 - **Fill in the working gas**
 - Preionization
- discharge phase
 - Toroidal magnetic field to confine plasma
 - Toroidal electric field to breakdown neutral gas into plasma
 - Toroidal electric field to heat the plasma
 - Plasma positioning
 - Diagnostics
- post-discharge phase

Plasma in Tokamak (GOLEM) - the least to do

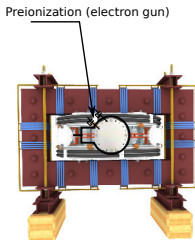

To do:

- session start phase:
 - Evacuate the chamber
- pre-discharge phase
 - Charge the capacitors
 - Fill in the working gas
 - **Preionization**
- discharge phase
 - Toroidal magnetic field to confine plasma
 - Toroidal electric field to breakdown neutral gas into plasma
 - Toroidal electric field to heat the plasma
 - Plasma positioning
 - Diagnostics
- post-discharge phase

Plasma in Tokamak (GOLEM) - the least to do

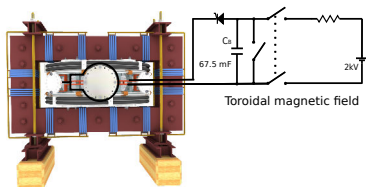

To do:

- session start phase:
 - Evacuate the chamber
- pre-discharge phase
 - Charge the capacitors
 - Fill in the working gas
 - Preionization
- discharge phase
 - **Toroidal magnetic field to confine plasma**
 - Toroidal electric field to breakdown neutral gas into plasma
 - Toroidal electric field to heat the plasma
 - Plasma positioning
 - Diagnostics
- post-discharge phase

Plasma in Tokamak (GOLEM) - the least to do

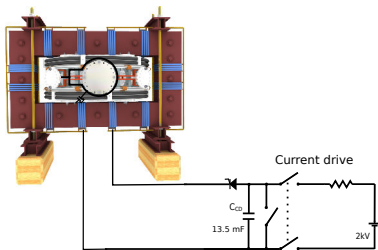

To do:

- session start phase:
 - Evacuate the chamber
- pre-discharge phase
 - Charge the capacitors
 - Fill in the working gas
 - Preionization
- discharge phase
 - Toroidal magnetic field to confine plasma
 - **Toroidal electric field to breakdown neutral gas into plasma**
 - **Toroidal electric field to heat the plasma**
 - Plasma positioning
 - Diagnostics
- post-discharge phase

Tokamak GOLEM - schematic experimental setup

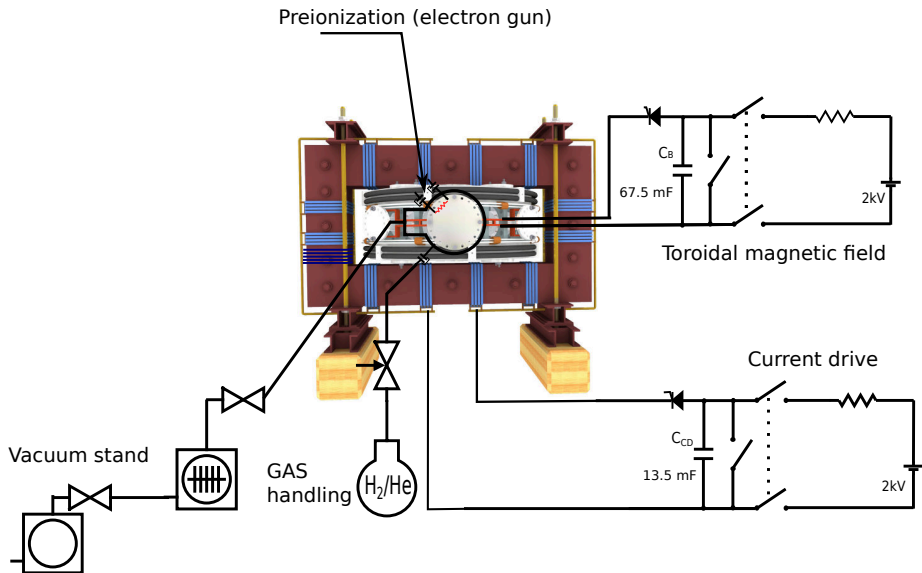

Remote control interface of the GOLEM tokamak

Introduction Working gas Preionization Magnetic field Electric field Submit

Set the pressure and type of the working gas from which the plasma is formed. Pressure must be high enough for plasma to form, but low enough for gas breakdown to occur.

Preionization (electron gun)

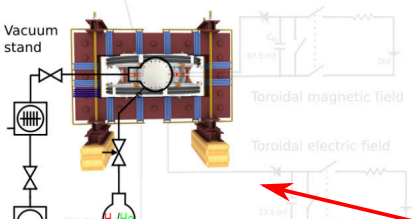

Vacuum stand

GAS handling H_2/He

Toroidal magnetic field

Toroidal electric field

Gas type and pressure $p_{WG} = 16 \text{ mPa}$

Hydrogen Helium

Next Set recommended value

rendering settings

3D model rendering method: Static image (fast) Interactive X3DOM (slower)

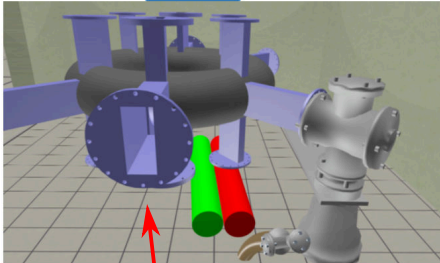

3D model rendering

engineering scheme

sliders and checkboxes

workflow buttons

Table of Contents

1 Introduction

2 The Tokamak (GOLEM)

- The GOLEM tokamak concept
- The GOLEM tokamak - guide tour
- The scenario to make the (GOLEM) tokamak discharge
- The scenario to discharge virtually
- The GOLEM tokamak basic diagnostics

3 The Tokamak GOLEM (remote) operation

4 The Electron energy confinement time calculation (rough estimation)

5 Conclusion

Introduce the working gas (Hydrogen x Helium)

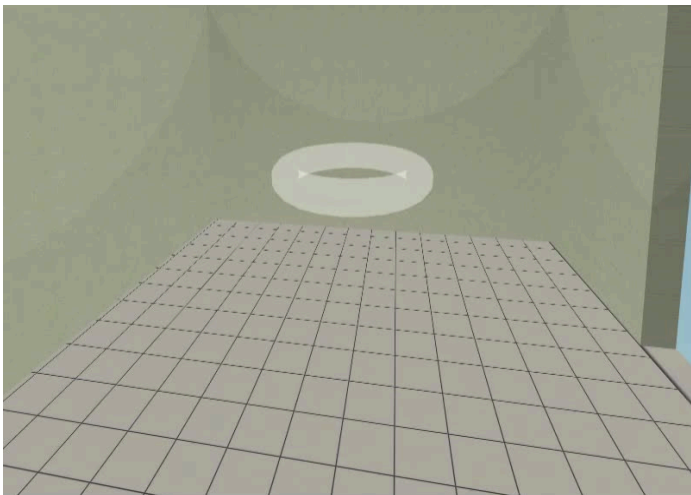

Switch on the preionization

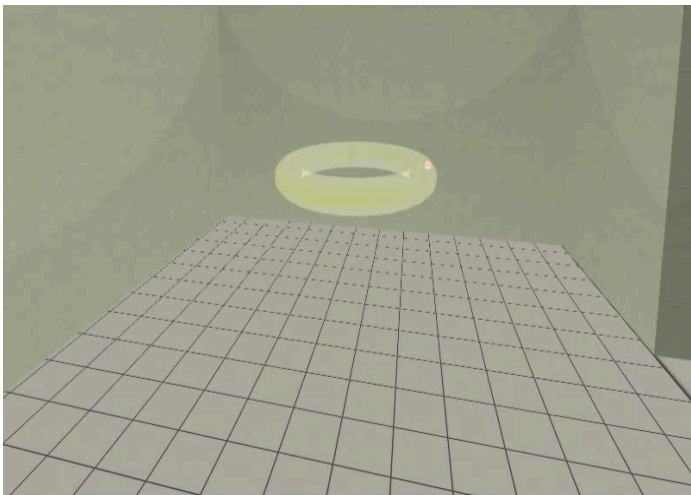

Introduce the magnetic field

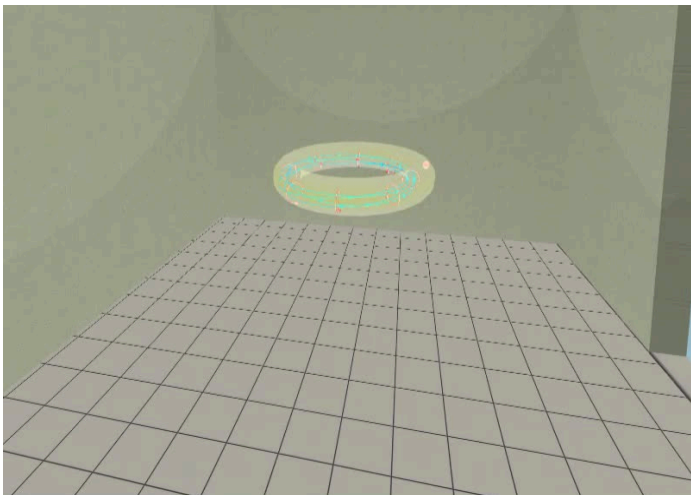

Introduce the electric field

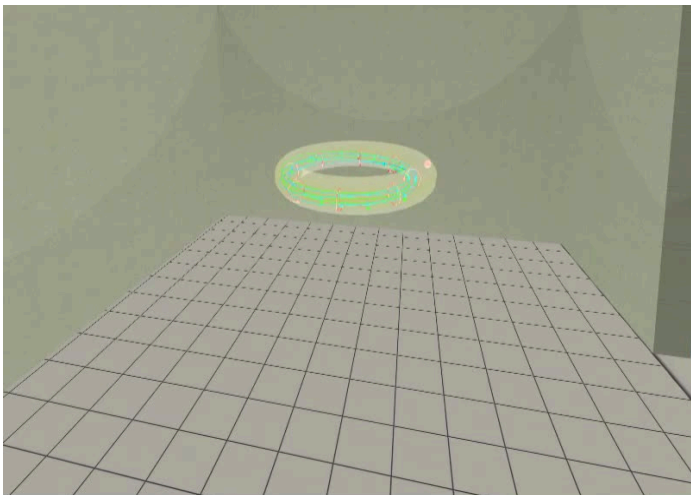

Plasma ..

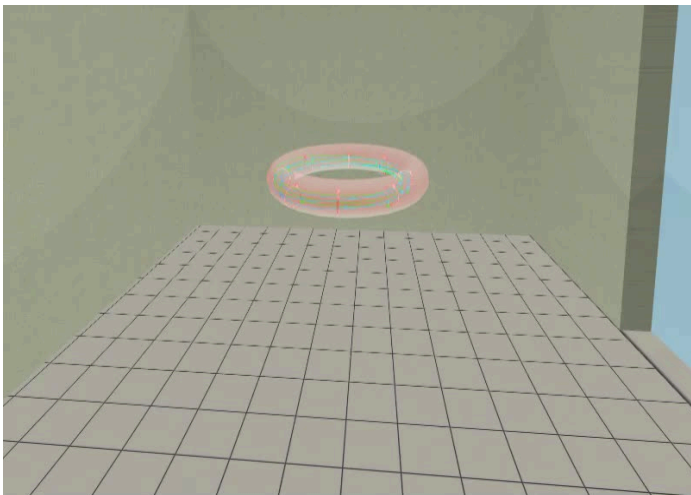

Table of Contents

1 Introduction

2 The Tokamak (GOLEM)

- The GOLEM tokamak concept
- The GOLEM tokamak - guide tour
- The scenario to make the (GOLEM) tokamak discharge
- The scenario to discharge virtually
- The GOLEM tokamak basic diagnostics

3 The Tokamak GOLEM (remote) operation

4 The Electron energy confinement time calculation (rough estimation)

5 Conclusion

The GOLEM tokamak - basic diagnostics

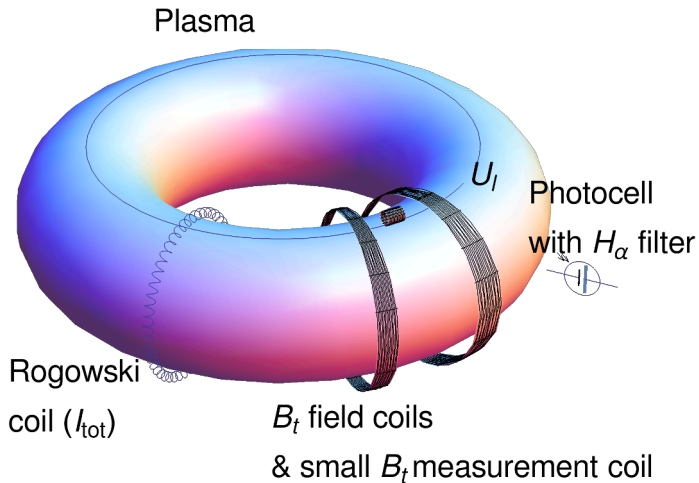

Hands on the GOLEM tokamak - equipment



Basic diagnostics - numerical processing, shot homepage

GOLEM - Shot #39187

Tokamak GOLEM - Shot Database - #39187

The date of discharge execution: 22-05-18 17:55:04
The session mission: GOLEM II -> EDU (MHD + biasing)
The session ID: 39183
The discharge comment: Vert & Rad Stab
Discharge command: `loop j, /Drigent.sh --discharge --UBT 1200 --TBT 0 --Ucd 450 --Tcd 350 --preionization 1 --gas H --pressure 10 --diagnostics.limitermirrorcoils "vacuum_shot=39109" --discharge.preionization "main_switch='on',powsup_heater=80,powsup_accel=100" --discharge.position_stabilization "main_switch='on',radial_switch='on',vertical_wavemode=3000,0,9000,-20;18000,0,20000,0,30000,0,vertical_switch='on',radial_wavemode=2000,0,3000,0,8000,-20;18000,0,19000,0,25000,0" --ScanDefinition "39184 39185" --comment "Vert & Rad Stab"`

Technological parameters

- Working Gas: $p_{\text{discharge, before}} = 1,66 \text{ mPa}$; $p_{\text{discharge, post}} = 10,40 \text{ mPa}$ ($p_{\text{HWC}}^{\text{request}} = 10 \text{ mPa}$ @ $N_{\text{HWC}}^{\text{request}} = H$)
- Toroidal magnetic field: $U_{\text{BI}}^{\text{request}} = 1200 \text{ V}$ @ $I_{\text{BI}}^{\text{request}} = 0,0 \text{ us}$
- Current drive field: $U_{\text{CD}}^{\text{request}} = 450 \text{ V}$ @ $I_{\text{CD}}^{\text{request}} = 350,0 \text{ us}$

Plasma

- Plasma: yes or no:
- Time parameters: $\Delta t_p = 15,08 \text{ ms}$ (from: $t_{\text{start}} = 2,49 \text{ ms}$, to: $t_{\text{end}} = 17,57 \text{ ms}$)

Plasma parameters

- Loop voltage: $\bar{U}_{\text{loop}} = 8,02 \text{ V}$; $\max_{r \in [0, \text{discharge}]} \bar{U}_{\text{loop}} = 9,89 \text{ V}$; $U_{\text{loopdown}} = 10,83 \text{ V}$
- Toroidal magnetic field: $\bar{B}_t = 0,40 \text{ T}$; $\max_{r \in [0, \text{discharge}]} \bar{B}_t = 0,57 \text{ T}$
- Plasma current: $I_p = 9,67 \text{ kA}$; $I_{\text{p, max}} = 9,67 \text{ kA}$; $I_{\text{p, min}} = 11,66 \text{ kA}$

On stage diagnostics

Data flow: measurement → digitization → analysis

Name	Experiment setup	Data acquisition system	Raw data	Analysis results
Basic Diagnostics				

Basic diagnostics - numerical processing, raw data

The image shows a web browser displaying a diagnostics interface for a Golem system. The browser address bar shows the URL: `http://golem.fjfi.cvut.cz/shots/39187/Devices/Oscilloscopes/TektrMSO56-a/`. The interface is titled "GOLEM - Shot #39187" and features a sidebar with navigation options like "Diagnostics", "Other", and "Navigation". The main content area is titled "On stage diagnostics" and includes a "Data flow" diagram with stages: "Name", "Experiment setup", "Data acquisition system", "Raw data", and "Analysis results". A red circle highlights a specific data point in the "Raw data" section, with a red arrow pointing from it to a file listing below. The file listing is titled "Index of /shots/39187/Devices/Oscilloscopes/TektrMSO56-a" and contains the following entries:

Name	Last modified	Size	Description
Parent Directory	-	-	-
BasicDiagnostics.sh	2022-05-18 17:58	3.2K	
ScreenshotAll.png	2022-05-18 17:58	184K	
TektrMSO56_ALL.csv	2022-05-18 17:58	3.9M	
Universals.sh	2022-05-18 17:58	1.2K	
das.jpg	2022-05-18 17:58	13K	
ls-all	2022-05-18 17:58	2.4K	
rawdata.jpg	2022-05-18 17:58	13K	

At the bottom of the page, it says: "Apache/2.4.38 (Debian) Server at golem.fjfi.cvut.cz Port 80". A red arrow from the left points to the "BasicDiagnostics.sh" file in the listing.

Basic diagnostics - numerical processing, Jupyter-notebook@GitLab Download & play

The screenshot displays a GitLab repository page for the project "Tokamak GOLEM Basic diagnostics". The main content area shows the Jupyter notebook "StandardDAS.ipynb" (19.83 KIB) with a "Download" button and a "Procedure" section. The procedure includes a link to "This notebook to download" and a "Prerequisites: function definitions" section. The prerequisites section lists the following code:

```
%matplotlib inline
import os
import numpy as np
import matplotlib.pyplot as plt
from scipy import constants, integrate, signal, interpolate
import sqlalchemy # high-level library for SQL in Python
import pandas as pd
import subprocess
```

The top navigation bar includes "About GitLab", "Pricing", "Talk to an expert", and a search bar. The left sidebar shows the repository structure, including "Files", "Commits", "Branches", "Tags", "Contributors", "Graph", "Compare", "Locked Files", "Issues", "Merge requests", "CI/CD", "Deployments", and "Collapse sidebar".

Basic diagnostics - numerical processing, Jupyter-notebook applied on the Discharge



Procedure ([This notebook to download](#))

[bash wrapper](#), [Error log](#)

Prerequisites: function definitions

Load libraries

```
In [1]: %matplotlib inline
import os
import numpy as np
import matplotlib.pyplot as plt
from scipy import constants, integrate, signal, interpolate
import sqlalchemy # high-level library for SQL in Python
import pandas as pd
import subprocess
```

For interactive web figures

```
In [2]: import holoviews as hv
hv.extension('bokeh')
import hvplot.pandas
```



For conditional rich-text boxes

```
In [3]: from IPython.display import Markdown
```

Loop voltage U_l @ the GOLEM tokamak

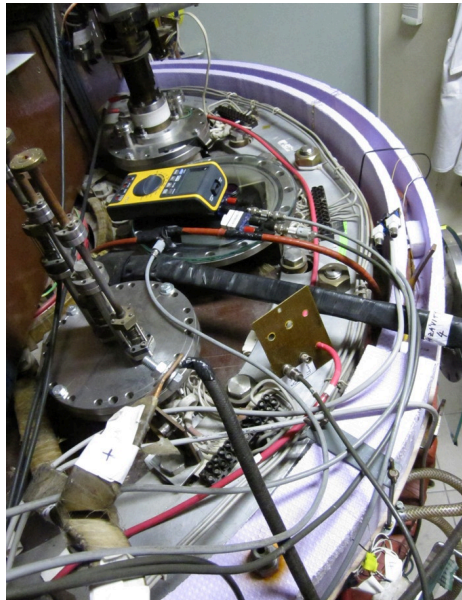
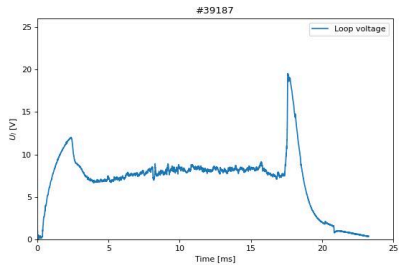
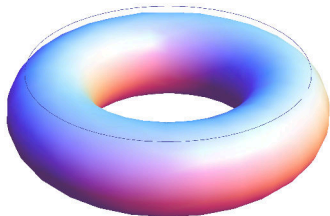

Basic diagnostics - numerical processing, U_{loop}

```
t_scale = 1e-3 if in_seconds else 1
if is_plasma:
    for t in (t_plasma_start, t_plasma_end):
        plt.axvline(t = t_scale, color='k', linestyle='--')
```

U_l management

Check the data availability

```
In [11]: loop_voltage = read_signal(shot_no, 'U_Loop')
polarity_CD = read_parameter(shot_no, 'CD_orientation')
if polarity_CD != 'CW': # T000 hardcoded for now!
    loop_voltage *= -1 # make positive
loop_voltage = correct_inf(loop_voltage)
loop_voltage.loc[is_CD] = 0
ax = loop_voltage.plot(grid=True)
show_plasma_limits()
ax.set(xlabel='Time [s]', ylabel='SU_LS [V]', title='Loop voltage SU_LS #{}'.format(shot_no));
```

```
Out[11]: [Text(0.5, 0, 'Time [s]'),
Text(0, 0.5, 'SU_LS [V]'),
Text(0.5, 1.0, 'Loop voltage SU_LS #39187')]
```

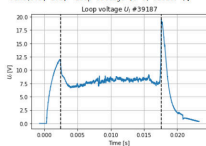

B_t calculation

Check the data availability

It is as magnetic measurement, so the raw data only give $\frac{dB_t}{dt}$

```
In [12]: dBt = read_signal(shot_no, 'U_BtCoil')
polarity_BT = read_parameter(shot_no, 'Bt_orientation')
if polarity_BT != 'CW': # T000 hardcoded for now!
    dBt *= -1 # make positive
dBt = correct_inf(dBt)
dBt -= dBt.loc[offset_s1].mean()
ax = dBt.plot(grid=True)
show_plasma_limits()
ax.set(xlabel='Time [s]', ylabel='dBt [V]', title='BtCoil raw signal #{}'.format(shot_no));
```

Toroidal magnetic field B_t @ the tokamak GOLEM

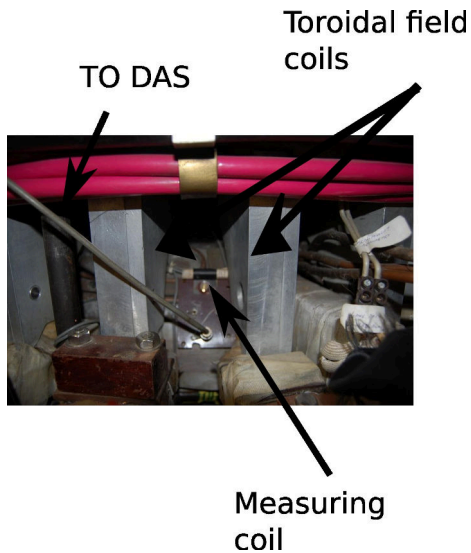
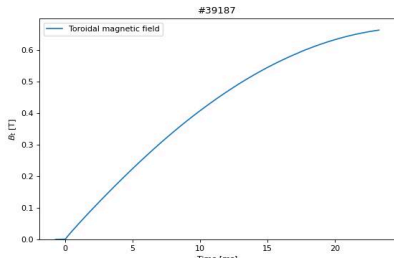

Basic diagnostics - numerical processing, B_t

B_t calculation

Check the data availability

It is as magnetic measurement, so the raw data only give $\frac{dB_t}{dt}$

```
In [12]: dBt = read_signal(shot_no, '0_BtCoil')
polarity_Bt = read_parameter(shot_no, 'Bt_orientation')
if polarity_Bt != 'CW':
    dBt *= -1 # make positive # 1000 hardcoded for now!
dBt = correct_infidBt
dBt = dBt.loc[offset_start:]
ax = dBt.plot(grid=True)
show_plasma_limits()
ax.set(xlabel='Time [s]', ylabel='dBt [B/s]', title='BtCoil_raw signal #{}'.format(shot_no));
```

```
Out[12]: [Text(0.5, 0, 'Time [s]'),
Text(0, 0.5, 'dBt [B/s]', title='BtCoil_raw signal #39187')]
Text(0.5, 1.0, 'BtCoil_raw signal #39187')]
```

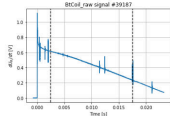

Integration (It is a magnetic diagnostic) & calibration

```
In [13]: K_BtCoil = float(read_parameter(shot_no, 'SystemParameters/K_BtCoil')) # Get BtCoil calibration factor
print('BtCoil calibration factor K_BtCoil: {} T/(Vs)'.format(K_BtCoil))
BtCoil calibration factor K_BtCoil=70.42 T/(Vs)
```

```
In [14]: BT = pd.Series(integrate.cumtrapz(dBt, axis=dBt.index, initial=0) * K_BtCoil,
index=dBt.index, name='Bt')
ax = BT.plot(grid=True)
show_plasma_limits()
ax.set(xlabel='Time [s]', ylabel='Bt [T]', title='Toroidal magnetic field Bt ts #{}'.format(shot_no));
```

```
Out[14]: [Text(0.5, 0, 'Time [s]'),
Text(0, 0.5, 'Bt [T]', title='Toroidal magnetic field Bt ts #39187')]
Text(0.5, 1.0, 'Toroidal magnetic field Bt ts #39187')]
```

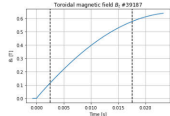

Total current I_{ch+p}

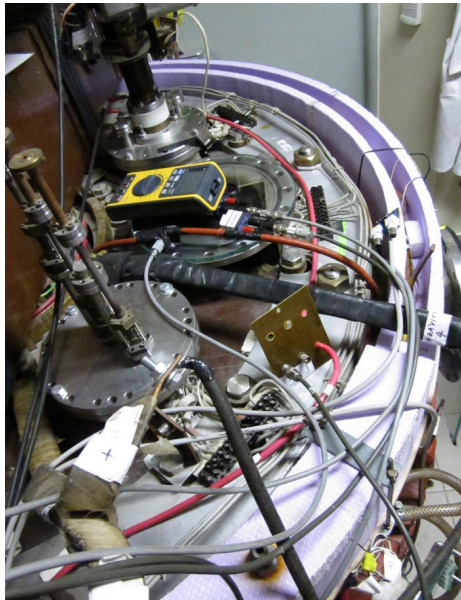
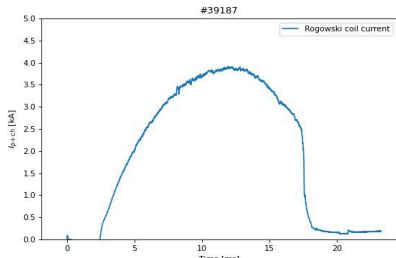
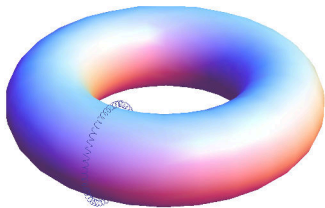

Basic diagnostics - numerical processing, U_{ch+p}

Chamber (+ Plasma) current I_{p+ch} calculation

The Rogowski coil around the chamber measures the total current contained within its boundaries. Therefore, if there is plasma, it measures the sum of the plasma and chamber currents. In a vacuum discharge it measures only the chamber current.

Check the data availability

Because it is a magnetic measurement, the raw data only gives $\frac{dI_{p+ch}}{dt}$

```
In [131]: dIpcch = read_signal(shot_no, 'RogCoil') # 5000 horizontal for now
if dIpcch[0] == 0:
    dIpcch = 1 # non active
dIpcch = correct_bias(dIpcch)
dIpcch = dIpcch * (1/500) # subtract offset
dIpcch[0] = 0
ax = dIpcch.plot(grid=True)
show plasma limits()
ax.set(xlabel='Time [s]', ylabel='dIpcch [A/s]', title='Rogowski coil raw signal #131'.format(shot_no))
```

Integration (it is a magnetic diagnostic) & calibration

```
In [130]: K_RogowskiCoil = float(read_parameter(shot_no, 'SystemParameters/K_RogowskiCoil')) # Get RogowskiCoil calibration factor
print('RogowskiCoil calibration factor: K_RogowskiCoil={0:1.6f}'.format(K_RogowskiCoil))
In [132]: Ipcch = pd.Series(integrate.cumtrapz(dIpcch, x=dIpcch.index, initial=0) * K_RogowskiCoil,
                          x=dIpcch.index, name='Ipcch')
ax = Ipcch.plot(grid=True)
show plasma limits()
ax.set(xlabel='Time [s]', ylabel='Ipcch [A]', title='Total (plasma+chamber) current #131'.format(shot_no))
```

Chamber current I_{ch} calculation

```
In [133]: R_chamber = float(read_parameter(shot_no, 'SystemParameters/R_chamber')) # Get Chamber resistivity
print('Chamber resistivity R_chamber={0}'.format(R_chamber))
Chamber resistivity R_chamber=0.007 Ohm
In [134]: I_chamber = float(read_parameter(shot_no, 'SystemParameters/I_chamber')) # Get Chamber inductance
print('Chamber inductance L_chamber={0}'.format(L_chamber))
Chamber inductance L_chamber=4e-06 H
```

```
In [131]: for i in range(1, len(shots)):
ax = I.plot(i)
ax.legend()
show plasma limits(i)
ax.set(xlabel='Time [s]', ylabel='I [A]', title='estimated chamber current and measured total')
plt.grid()
```

Plasma current I_p calculation

If there is plasma, the plasma current can be estimated as the difference between the total measured current and the estimated chamber current $I_p = I_{p+ch} - I_{ch}$

```
In [122]: if is_plasma:
    Ip_name = Ipcch - loop_voltage/R_chamber # creates a new Series
    Ip = Ipcch - I_ch
    Ip.name = 'Ip'
    Ip.name.plot(grid=True, label='naive Ii (ch)+Ii (ch)')
    ax = Ip.plot(grid=True, label='using SQ_L = R_ch I_ch - L_ch / (R_ch I_ch) dt')
    ax.legend()
    show plasma limits()
    ax.set(xlabel='Time [s]', ylabel='Ip [A]', title='Plasma current Ii (pp)')
else:
    Ip = Ipcch * 0 # no current
    heating
```

Out[122]: Plasma detected

plasma lifetime of 15.1 ms, from 2.5 ms to 17.6 ms

```
In [131]: fig = plt.figure(dpi=200)
for i in range(1, len(shots)):
    ax = I.plot(i)
```

Visible radiation

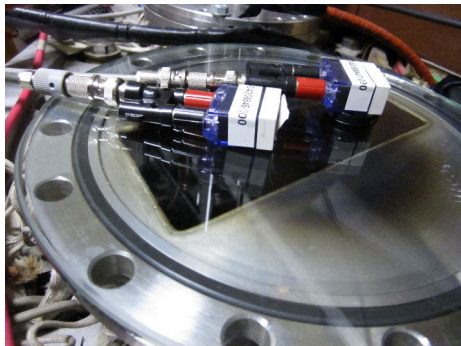
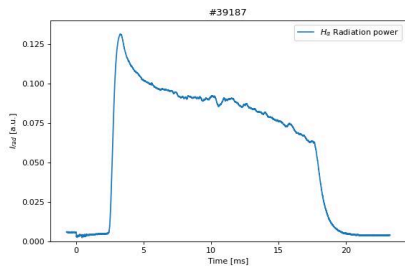
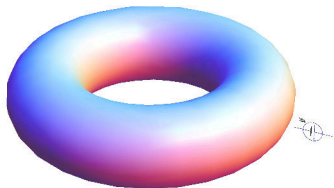

Electron density n_e interferometry measurement scheme

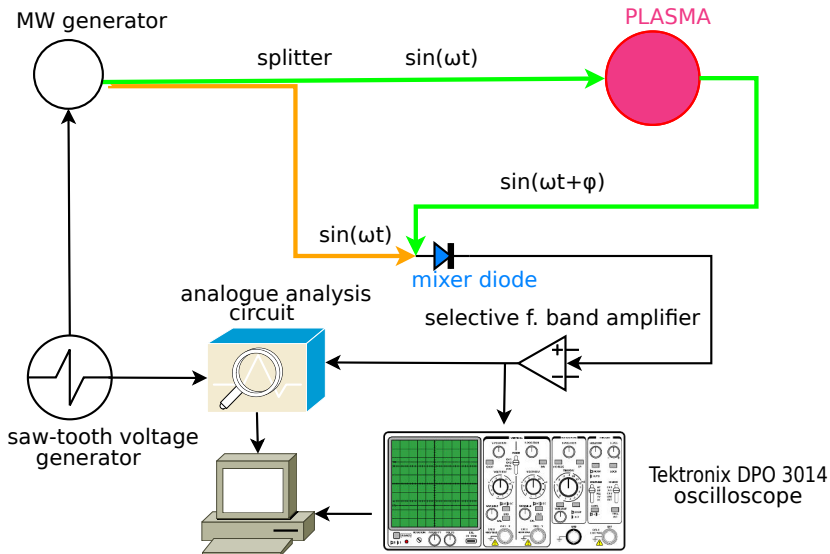

The GOLEM tokamak interferometry HW

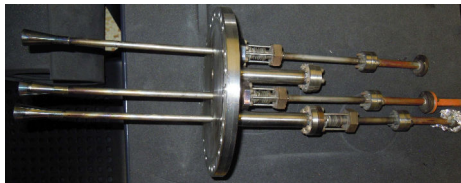

Finally "Typical", well executed discharge @ GOLEM

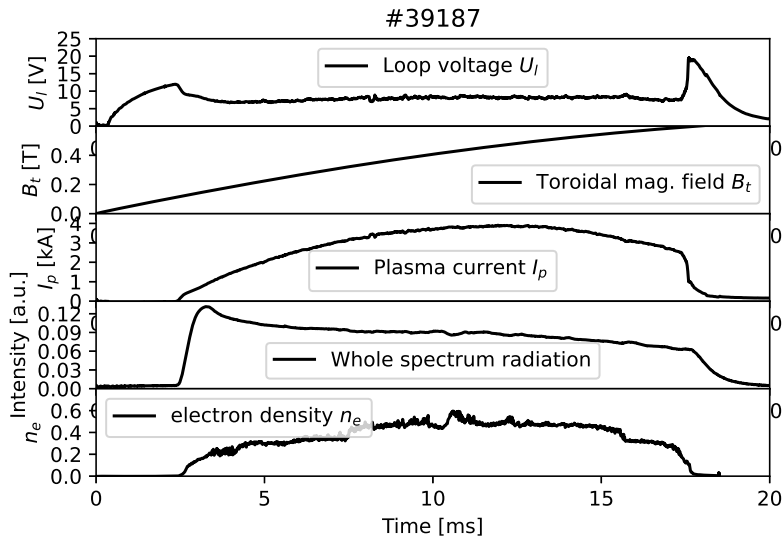

Shot homepage (≈ 2 minutes after discharge execution)

GOLEM # Shot #40631
autoreload



Diagnostics

BasicDiagnostics
DoubleRakeProbe
Interferometry
LimiterInterlocks
ScriptsAndProbes

Other

View Showroom

Navigation

Next
Previous
Current

Go to shot
40631

GOLEM UTILS

Home
Plot data
Shot interval plot
Manipulators control

Database operations

Shots listing
Shots filtering

Tokamak GOLEM - Shot Database - #40631

The date of discharge execution 23-02-07 17:23:54

The session mission 1Final -> Dringent service

The session ID 40605

The discharge comment Rake probe 50mm

Discharge command jDringent.sh --discharge --UBt 800 --Tbt 0 --Utd 450 --Tod 500 --preionization 1 --gas H --pre issue 15 --diagnostics.limiterinterlocks.vacuum_shot=40615F --discharge.preionization "m air_switch=on;powsup_heater=80;powsup_accel=100" --infrastructure.position_stabilization "main_switch=on;radial_switch=on;vertical_waveform=1000,0.8000,-20,10000,-25,12000,-10,30000,0;vertical_switch=on;radial_waveform=2000,0.3000,0.7000,-20,9500,-25,10000,-20,30000,2,25000,0" --ScanDefinition 40625 40629F --comment "Rake probe 50mm"

[Shot Logbook]

Technological parameters

- Working Gas: $P_{discharge, before} = 2.46$ mPa; $P_{discharge, after} = 5.04$ mPa ($P_{WG}^{response} = 15$ mPa @ $\Delta T_{WG}^{response} = 4$ H)
- Toroidal magnetic field: $U_{B_t}^{response} = 800$ V @ $I_{B_t}^{response} = 0.0$ us
- Current drive field: $U_{ECC}^{response} = 450$ V @ $I_{ECC}^{response} = 500.0$ us

Plasma:

- Plasma: yes or no:
- Time parameters: $\Delta t_p = 10.88$ ms ($t_{rom_start} = 2.67$ ms, $t_{rom_end} = 13.54$ ms)

Plasma parameters:

- Loop voltage: $U_{loop} = 6.82$ V; $max_{T_{loop}}(I_{discharge}) U_{loop} = 16.17$ V; $U_{breakdown} = 0.00$ V
- Toroidal magnetic field: $B_t = 0.24$ T; $max_{T_{discharge}}(B_t) = 0.36$ T
- Plasma current: $I_p = 2.28$ kA; $max_{T_{discharge}}(I_p) = 2.92$ kA; $t_p^{max} = 0.00$ ms

Basic Diagnostics

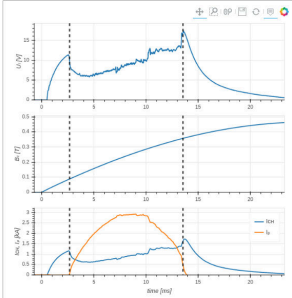

On stage diagnostics











Data flow	measurement	digitization	analysis	Analysis results
Name	Experiment setup	Data acquisition system	Raw data	Analysis results
Basic Diagnostics 				
Double rake probe 				Without Analysis 

Table of Contents

- 1 Introduction
- 2 The Tokamak (GOLEM)
- 3 The Tokamak GOLEM (remote) operation**
- 4 The Electron energy confinement time calculation (rough estimation)
- 5 Conclusion
- 6 Appendix

Table of Contents

- 1 Introduction
- 2 The Tokamak (GOLEM)
- 3 The Tokamak GOLEM (remote) operation**
 - Control room
 - Data handling @ the Tokamak GOLEM
- 4 The Electron energy confinement time calculation (rough estimation)
- 5 Conclusion
- 6 Appendix

Remote control interface of the GOLEM tokamak

Introduction Working gas Preionization Magnetic field Electric field Submit

Set the pressure and type of the working gas from which the plasma is formed. Pressure must be high enough for plasma to form, but low enough for gas breakdown to occur.

Preionization (electron gun)

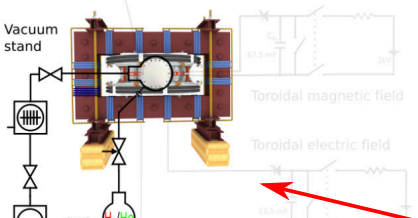

Vacuum stand

Toroidal magnetic field

Toroidal electric field

GAS handling

Gas type and pressure $p_{WG} = 16 \text{ mPa}$

Hydrogen Helium

Next Set recommended value

3D model rendering method: Static image (fast) Interactive X3DOM (slower) rendering settings

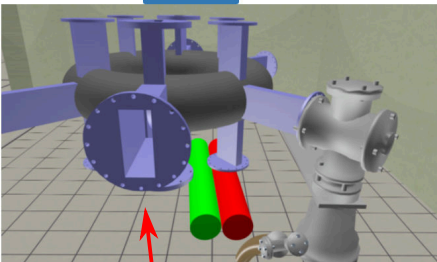

3D model rendering

engineering scheme

sliders and checkboxes

workflow buttons

Control room: Introduction

GOLEM remote Introduction **Control room** Live Results

Prague Access: Level 1 Help

Introduction Working gas Preionization Magnetic field Current drive Submit

This web interface will walk you through the process of configuring a discharge in the GOLEM tokamak. All settable values are perfectly safe. Proceed through each step by setting the desired values and then clicking the [Next](#) button. You can always go to a specific step by clicking its tab.

Preionization (electron gun)

Vacuum stand

Preionization (electron gun)

Toroidal magnetic field

Current drive

GAS handling H_2/He

23 mF C_p 2kV

11.3 mF C_p 2kV

[Next](#)

3D model rendering method: [Static image \(fast\)](#) [Interactive X3DOM \(slower\)](#)

Control room: Working gas

GOLEM remote Introduction Control room Live Results

Introduction Working gas Preionization Magnetic field Electric field Submit

Set the pressure and type of the working gas from which the plasma is formed. Pressure must be high enough for plasma to form, but low enough for gas breakdown to occur.

Preionization (electron gun)

Vacuum stand

Toroidal magnetic field

Toroidal electric field

GAS handling

H_2/H_2O

Gas type and pressure p_{gas} : 38 mPa

Hydrogen Helium

Next Set recommended value

3D model rendering method Static image (best) Interactive X3DOM (preview)

https://golem.f4t.ovu.cz/remote/control_room/?access_token=02d74f7334f770040e77821158602c2&id=ef&action=Master#control-sub-gas

Control room: Preionization

GOLEM remote Introduction Control room Live Results

Introduction Working gas Preionization Magnetic field Electric field Submit

The neutral working gas must first be ionized in order to break down into a plasma. Using the electron gun will locally ionize the gas. Without any ionization, no plasma can form.

Preionization (electron gun)

Vacuum stand

GAS handling

Toroidal magnetic field

Toroidal electric field

67.5 mF

13.5 mF

20V

20V

ionization method

Electron gun No ionization

Next

3D model rendering method Static image (best) Interactive X3DOM (viewer)

Control room: Magnetic field B_t

GOLEM version: Introduction Control room Live Results

Press F11 to exit full screen
3D model rendering method: Static image (best) Interactive X3DOM (viewer)

Introduction Working gas Preionization **Magnetic field** Electric field Submit

Set the voltage on the capacitors to be discharged into the toroidal field coils. The higher the voltage, the larger the magnetic field confining the plasma.

Preionization (electron gun)

Vacuum stand

Toroidal magnetic field

Toroidal electric field

GAS handling

Capacitor voltage $U_{C_1} = 600$ V

Next Set recommended value

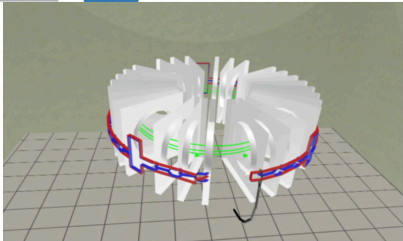

Control room: Current drive E_{cd}

GOLEM remote Introduction Control room Live Results

the Torneo Politecnico, Italy Group 1 Access: Level 2 Help

Introduction Working gas Preionization Magnetic field **Electric field** Submit

Set the voltage on the capacitors to be discharged into the [primary transformer winding](#). The higher the voltage, the larger the electric field creating and heating the plasma. The electric field capacitors are discharged after a configurable delay with respect to the magnetic field capacitors.

Preionization (electron gun)

Vacuum stand

Toroidal magnetic field

Toroidal electric field

GAS handling

Time delay of electric field start after the magnetic field starts t_{cd} : 0 micro seconds

Capacitor voltage U_{cd} : 400 V

Next Set recommended value

3D model rendering method Static image (best) Interactive X3DOM (preview)

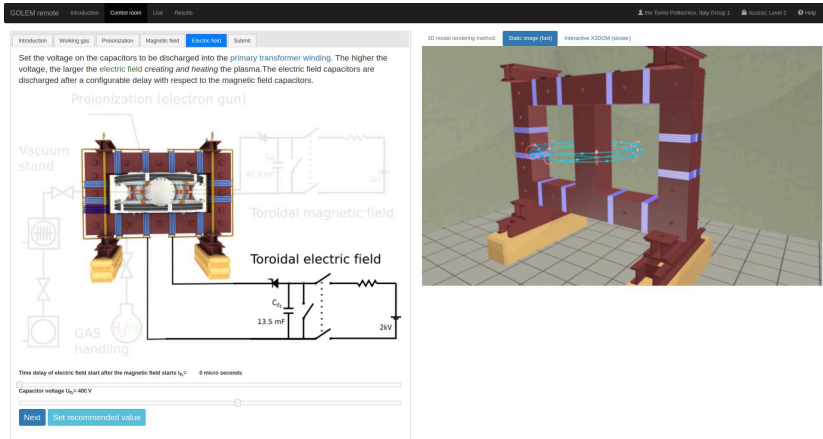

Control room: ... and Submit

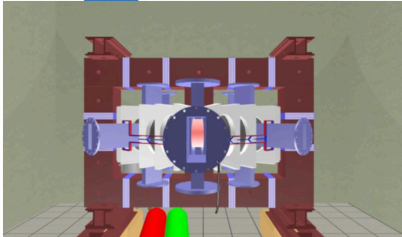

The screenshot displays the GOLEM control room interface. At the top, a navigation bar includes 'GOLEM remote', 'Introduction', 'Control room', 'Live', and 'Results'. On the right, it shows the user 'The Torneo Politecnico, Italy Group 1', 'Access: Level 2', and a 'Help' icon.

The main content area is divided into two sections. The left section is a form titled 'Submit'. It features a tabbed interface with 'Introduction', 'Working gas', 'Preionization', 'Magnetic field', 'Electric field', and 'Submit' (which is currently selected). Below the tabs, there is a text input field with the instruction: 'Write a comment describing your discharge configuration, i.e. the scientific aim of your experiment. Or just leave a friendly message.' Below the input field is a 'Comment' label and a text box. Further down, there is a 'Submit' button and a note: 'Click the Submit button to send your configuration into the queue.' Below this note are two buttons: 'Watch the discharge live!' and 'Go back to introduction'.

The right section is a 3D model rendering of the tokamak, labeled '3D model rendering method'. It includes a 'Static image (best)' button and an 'Interactive X3DOM (slower)' button. The 3D model shows a complex, cylindrical structure with various components, including a central toroidal field coil and a central solenoid, all rendered in a stylized, colorful manner.

Shot homepage (≈ 2 minutes after discharge execution)

GOLEM # Shot #40631
autoreload



Diagnostics

BasicDiagnostics
DoubleRakeProbe
Interferometry
LimiterMicroVista
ScribbleProbes

Other

View Showroom

Navigation

Next
Previous
Current

Go to shot
40631

Golem utils

Home
Plot data
Shot interval plot
Manipulators control

Database operations

Shots listing
Shots filtering

Tokamak GOLEM - Shot Database - #40631

The date of discharge execution 23-02-07 17:23:54

The session mission 1Final -> Dringent service

The session ID 40605

The discharge comment Rake probe 50mm

Discharge command jDringent.sh --discharge --UBt 800 --Tbt 0 --Utd 450 --Tod 500 --preionization 1 --gas H --pre issue 15 --diagnostics.limitermicrovista.vacuum_shot=40615 --discharge.preionization "m air_switch=on;powsup_heater=80;powsup_accel=100" --infrastructure.position_stabilization "main_switch=on;radial_switch=on;vertical_waveform=1000,0.8000,-20,10000,-25,12000,-10,30000,0;vertical_switch=on;radial_waveform=2000,0.3000,0.7000,-20,9500,-25,10000,-20,30000,2,25000,0" --ScanDefinition 40625 40629 --comment "Rake probe 50mm"

[Shot Logbook]

Technological parameters

- Working Gas: $P_{discharge, before} = 2.46$ mPa; $P_{discharge, pre} = 5.04$ mPa ($P_{WG}^{response} = 15$ mPa @ $\Delta P_{WG}^{response} = 4$)
- Toroidal magnetic field: $U_{B_t}^{response} = 800$ V @ $I_{B_t}^{response} = 0.0$ us
- Current drive field: $U_{Ecd}^{response} = 450$ V @ $I_{Ecd}^{response} = 500.0$ us

Plasma:

- Plasma: yes or no:
- Time parameters: $\Delta t_p = 10.88$ ms ($t_{rom_start} = 2.67$ ms, $t_{rom_end} = 13.54$ ms)

Plasma parameters:

- Loop voltage: $U_{loop} = 6.82$ V; $max_{T_{inj}}(I_{discharge})$; $U_{loop} = 16.17$ V; $U_{breakdown} = 0.00$ V
- Toroidal magnetic field: $B_t = 0.24$ T; $max_{T_{inj}}(I_{discharge})$; $B_t = -0.36$ T
- Plasma current: $I_p = 2.28$ kA; $max_{T_{inj}}(I_{discharge})$; $I_p = 2.92$ kA; $t_p^{max} = 0.00$ ms

Basic Diagnostics

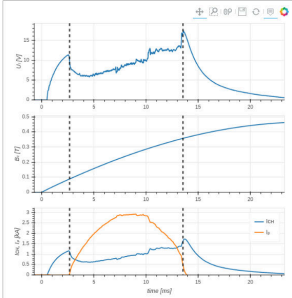

On stage diagnostics













Data flow	measurement	digitization	Raw data	analysis	Analysis results
Name	Experiment setup	Data acquisition system	Raw data	Analysis	Analysis results
<p>Basic Diagnostics</p> 					
<p>Double rake probe</p> 					<p>Without Analysis</p> 

Table of Contents

- 1 Introduction
- 2 The Tokamak (GOLEM)
- 3 The Tokamak GOLEM (remote) operation**
 - Control room
 - Data handling @ the Tokamak GOLEM
- 4 The Electron energy confinement time calculation (rough estimation)
- 5 Conclusion
- 6 Appendix

GOLEM basic Data Acquisition System (DAS)

- $U_I, U_{B_t}, U_{I_{p+ch}}, I_{rad}$
- $\Delta t = 1\mu s / f = 1MHz$.
- Integration time = 40 ms, thus DAS produces 6 columns x 40000 rows data file.
- Discharge is triggered at 5th millisecond after DAS to have a zero status identification.



Data file example, DAS $\Delta t = 1\mu s / f = 1MHz$ (neutral gas into plasma breakdown focused)

t	$\approx U_I$	$\approx U_{\frac{dB_T}{dt}}$	$\approx U_{\frac{d(I_{p+ch})}{dt}}$	$\approx I_{rad}$
:	:	:	:	:
:	:	:	:	:
first	\approx	7405	lines ..	:
:	:	:	:	:
:	:	:	:	:
0.007383	1.53931	0.390015	0.048828	0.001831
0.007384	1.53686	0.395508	0.067749	0.00061
0.007385	1.54053	0.391235	0.079956	0.00061
0.007386	1.53686	0.38147	0.072632	0
0.007387	1.54297	0.397949	0.059204	0.00061
0.007388	1.54053	0.384521	0.05249	0.00061
0.007389	1.54053	0.39856	0.068359	0.001221
0.00739	1.54053	0.393677	0.082397	0.001221
0.007391	1.53809	0.38208	0.072632	0.001221
0.007392	1.54297	0.400391	0.056763	0.00061
0.007393	1.54419	0.383911	0.053101	0.00061
0.007394	1.53931	0.397339	0.068359	0.001221
0.007395	1.54297	0.391846	0.084229	0.00061
0.007396	1.54541	0.394897	0.074463	0.00061
0.007397	1.54297	0.388184	0.056763	0.001221
0.007398	1.54297	0.391846	0.056763	0.00061
0.007399	1.54297	0.394287	0.06897	0.00061
:	:	:	:	:
:	:	:	:	:
next	\approx	32500	lines ..	:
:	:	:	:	:
:	:	:	:	:

Data access

All the recorded data and the settings for each discharge (shot) are available at the GOLEM website. The root directory for the files is:

```
http://golem.fjfi.cvut.cz/shots/<#ShotNo>/
```

The most recent discharge has the web page:

```
http://golem.fjfi.cvut.cz/shots/0
```

Particular data from DAS specified with <DASname> and <DASchannelidentifier> have the format:

```
http:  
//golem.fjfi.cvut.cz/<#ShotNo>/<DASname>/<DASchannelidentifier>
```

Jupyter (python)

```
import numpy as np
import matplotlib.pyplot as plt

shot_no = 39187
identifier = "U_loop.csv"
DAS='Diagnostics/BasicDiagnostics/Results/'
# create data cache in the 'golem_cache' folder
ds = np.DataSource('golem_cache')
#Create a path to data and download and open the file
base_url = "http://golem.fjfi.cvut.cz/shots/"
data_file = ds.open(base_url + str(shot_no)+ '/' +DAS +identifier)
#Load data from the file and plot to screen and to disk
data = np.loadtxt(data_file,delimiter=",")
plt.title('#'+str(shot_no))
plt.plot(data[:,0]*1000, data[:,1]) #1. column vs 2. column
plt.xlabel('Time [ms]');plt.ylabel('$U_1$ [V]');
plt.savefig('graph.jpg')
plt.show()

#Run it: save it as script.py and run "python script.py" or execute in a
```

Matlab

```
ShotNo=39187
baseURL='http://golem.fjfi.cvut.cz/shots/';
diagnPATH='/Diagnostics/BasicDiagnostics/Results/U_loop.csv';
%Create a path to data
dataURL=strcat(baseURL,int2str(ShotNo),diagnPATH);
% Write data from GOLEM server to a local file
urlwrite(dataURL,'LoopVoltage');
% Load data
data = load('LoopVoltage', '\t');
% Plot and save the graph
f = figure('visible', 'off');
hold on
plot(data(:,1)*1000, data(:,2), '.');
xlabel('Time [ms]')
ylabel('U_1 [V]')
hold off
print -djpeg plot.jpg
close(f)
exit;
```

Octave

```
ShotNo=39187
baseUrl='http://golem.fjfi.cvut.cz/shots/';
diagnPATH='/Diagnostics/BasicDiagnostics/Results/U_loop.csv';
%Create a path to data
dataURL=strcat(baseUrl,int2str(ShotNo),diagnPATH);
% Write data from GOLEM server to a local file
urlwrite(dataURL,'U_Loop.csv');
% Load data
data = load('U_Loop.csv', '\t');
% Plot and save the graph
plot(data(:,1)*1000, data(:,2), '.');
xlabel('time [ms]')
ylabel('U_{loop} [V]')
saveas(gcf, 'plot', 'jpg');
exit;
```

Gnuplot

```
identifier = 'U_loop.csv' ;
ShotNo = '39187'
# Create a path to the data
DAS='Diagnostics/BasicDiagnostics/Results/'
baseURL='http://golem.fjfi.cvut.cz/shots/'
DataURL= baseURL.ShotNo.'/'.DAS.identifier
set datafile separator ',';
set title "Uloop for #".ShotNo;
! wget -q @DataURL ;# Write data from GOLEM erver to a local file
# Plot the graph from a local file
set xrange [0:0.02];set xlabel 'Time [s]';set ylabel 'U_1 [V]'
set terminal jpeg; plot identifier u 1:2 w l t 'Uloop'
```

```
shot_no=39187;\
signal_id="Diagnostics/BasicDiagnostics/Results/U_loop.csv";\
gnuplot -p -e "set title \"Golem\";set datafile separator \"\",\"\";\
set xlabel \"t [s]\";set ylabel \"U\";\
plot \"< \
wget -q -O - http://golem.fjfi.cvut.cz/shots/$shot_no/$signal_id\" \
w l t \"U\""
```

GNU Wget

GNU Wget is a free software package for retrieving files using HTTP, HTTPS and FTP, the most widely-used Internet protocols. It is a non-interactive commandline tool, so it may easily be called from scripts, cron jobs, terminals without X-Windows support, etc.

- Runs on most UNIX-like operating systems as well as Microsoft Windows.
- Homepage: <http://www.gnu.org/software/wget/>
- Basic usage:
 - To get U_l : `wget http://golem.fjfi.cvut.cz/utills/data/<#ShotNo>/loop_voltage`
 - To get whole shot: `wget -r -nH -cut-dirs=3 -no-parent -l2 -Pshot http://golem.fjfi.cvut.cz/shots/<#ShotNo>`

Excel

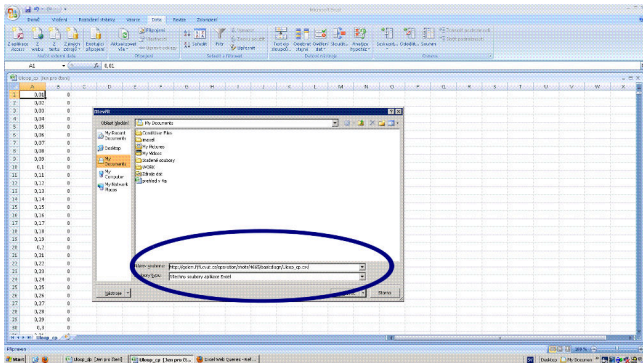

File→Open→

`http://golem.fjfi.cvut.cz/utils/data/<#ShotNo>/<identifier>`

Spreadsheets (Excel and others)

are not recommended, only tolerated.

Table of Contents

- 1 Introduction
- 2 The Tokamak (GOLEM)
- 3 The Tokamak GOLEM (remote) operation
- 4 The Electron energy confinement time calculation (rough estimation)
- 5 Conclusion
- 6 Appendix

Energy balance of the house

Closed windows & insulation

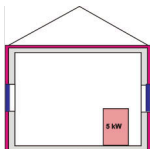

Closed windows

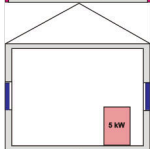

Open windows

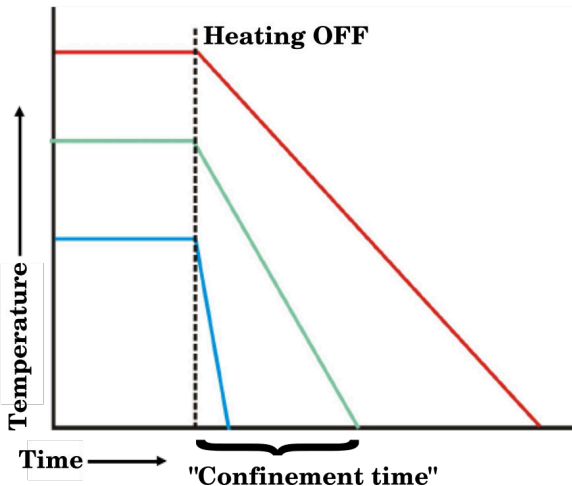
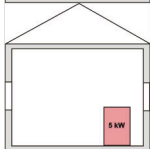

Energy balance of the tokamak

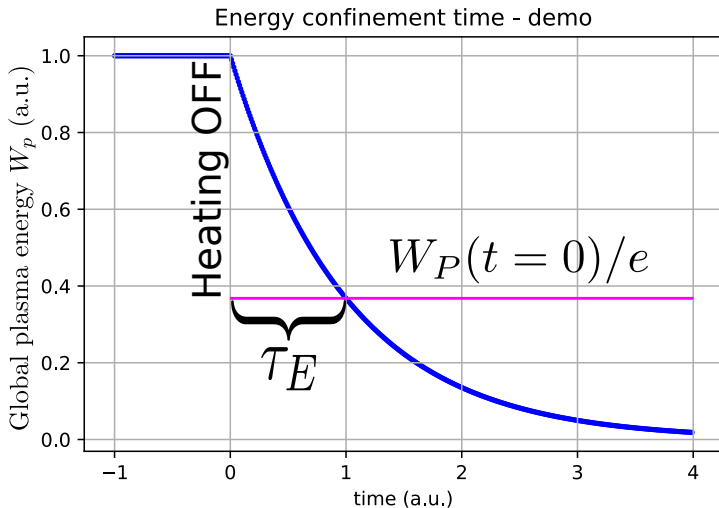

Energy confinement time

Under the assumption of a simplified power balance, the heating power P_H is partially absorbed in the plasma and leads to an increase of the plasma energy W_p and the rest is lost as the loss power P_{Loss}

$$P_H = \frac{dW_p}{dt} + P_{Loss}$$

The energy confinement time is defined as the characteristic time scale of the exponential decay of the plasma energy W_p due to the loss power P_{Loss} :

$$\tau_E = \frac{W_p}{P_{Loss}} = \frac{W_p}{P_H - dW_p/dt}$$

Choosing the quasistationary phase of the plasma discharge, where $\frac{dW_p}{dt} = 0$ gives:

$$\tau_E(t) = \frac{W_p(t)}{P_H(t)}$$

The discharge - quasistationary phase

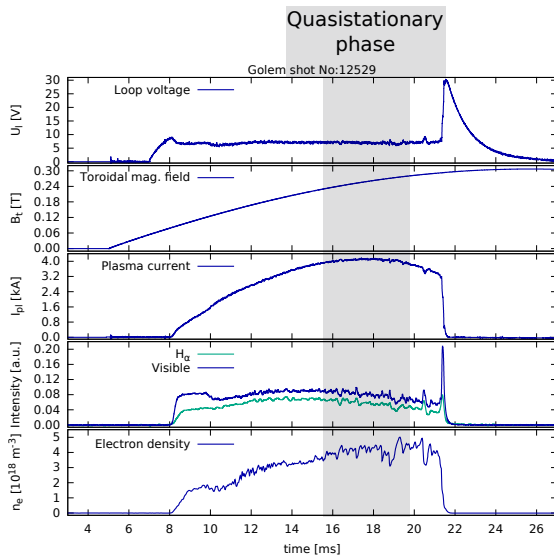

Plasma heating power

On the GOLEM tokamak the only heating mechanism of the plasma is ohmic heating P_{OH} resulting from the plasma current I_p flowing in a conductor with finite resistivity R_p . The time dependence of the ohmic heating power can be calculated as:

$$P_H(t) = P_{OH}(t) = R_p(t) \cdot I_p^2(t)$$

Plasma Energy

The global plasma energy content W_p can be simply calculated from the temperature estimation $T_e(0, t)$, average density n_e and plasma volume V_p , based on the ideal gas law, taking into account the assumed

$T_e(r, t) = T_e(0, t) \left(1 - \frac{r^2}{a^2}\right)^2$ temperature profile:

$$W_p(t) = V_p \frac{n_e k_B T_e(0, t)}{3}.$$

The information that the magnetic field reduces the degrees of freedom of the particles to two has been used to derive this formula.

- $V_p \approx 80 \text{ l}$

Central Electron Temperature estimation (Spitzer Formula)

The time evolution of the central electron temperature $T_e(0, t)$ is calculated from equation based on Spitzer's resistivity formula (see eg. [5],[6]):

$$T_e(0, t) = \left(\frac{R_0}{a^2} \frac{8Z_{eff.}}{1544} \frac{1}{R_p(t)} \right)^{2/3}, [eV; m, \Omega]$$

For particular case of the GOLEM tokamak it says:

$$T_e(0, t) = 0.9 \cdot \left(\frac{I_p(t)}{U_I(t)} \right)^{2/3}, [eV; A, V]$$

Towards Electron energy confinement time τ_{eE}

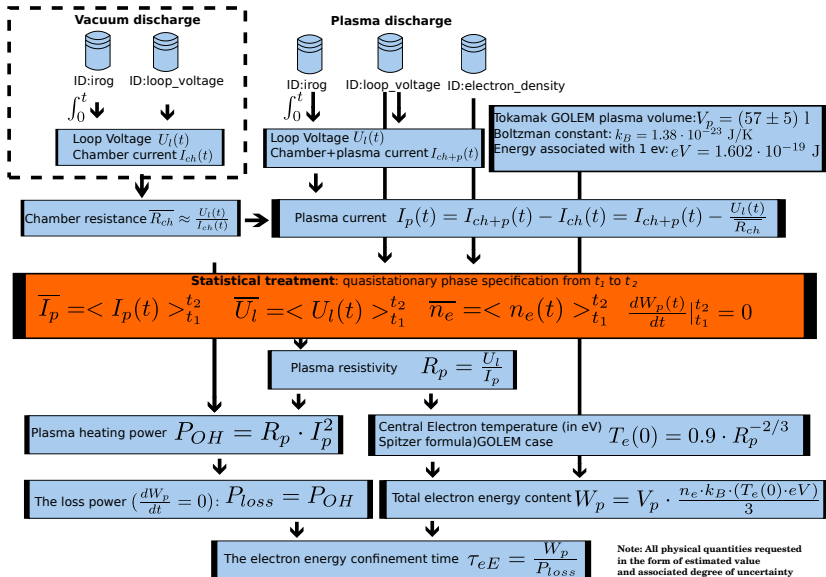

The GOLEM tokamak - standard diagnostics

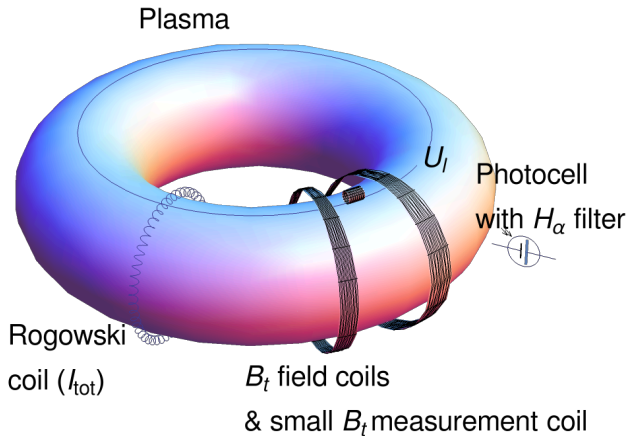

Hands on the GOLEM tokamak - equipment



The GOLEM tokamak interferometry HW

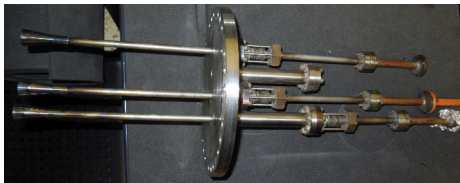

Vacuum x Plasma discharge @ Oscilloscope

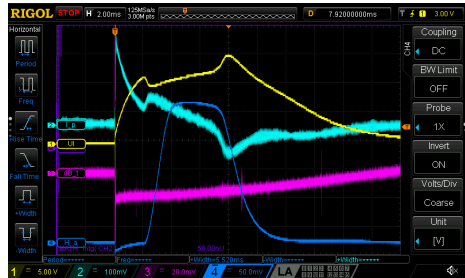
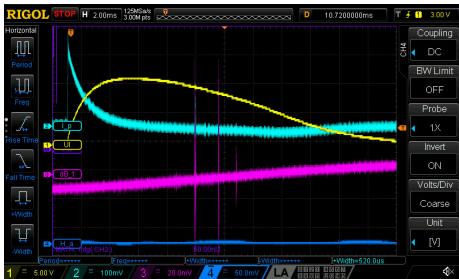

Vacuum x Plasma shot

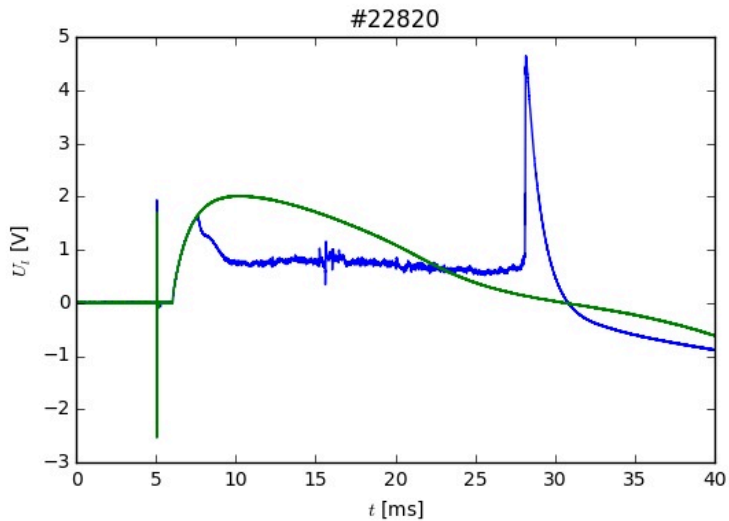

Table of Contents

- 1 Introduction
- 2 The Tokamak (GOLEM)
- 3 The Tokamak GOLEM (remote) operation
- 4 The Electron energy confinement time calculation (rough estimation)
- 5 Conclusion**
- 6 Appendix

The global schematic overview of the GOLEM experiment

LEVEL 1

Tokamak technology setup

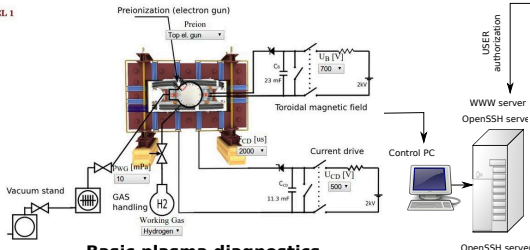

Basic plasma diagnostics

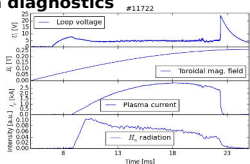
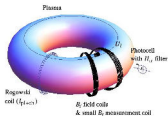

internet



**Virtual control room
(remote participation)**

WWW control interface

HTML & PHP scripts

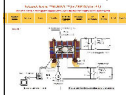

SSH control interface

WINDOWS via putty



LINUX via ssh
or ssh+X tunnel
(advanced mode)

Data presentation

HTML (www pages)

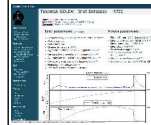

Data handling

- *wget
- *gnuplot
- *idl
- *mathematica
- *matlab
- *etc...

Production

- Everything via <http://golem.fjfi.cvut.cz/Cadarache>
 - This presentation
 - Control rooms
 - Contact: Vojtech Svoboda,
+420 737673903,
vojtech.svoboda@fjfi.cvut.cz
 - Videoconference:
<https://meet.google.com/hnv-qjhu-xvi>



Recommended values for the GOLEM tokamak operation

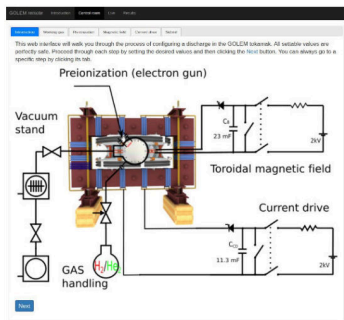

- Preionization: Top electron gun
- Gas: Hydrogen. A Working gas pressure: p_{WG} [mPa] $< 0, 40 >$ mPa
- A voltage to charge the Current drive field E_t capacitor: U_{E_t} [V] $< 400, 700 >$ V
- A voltage to charge the Toroidal magnetic field B_t capacitor: U_{B_t} [V] $< 600, 1200 >$ V
- Time delay of the E_t trigger with respect to the B_t trigger: T_{CD} [μ s] $< 0, 10000 >$ μ s

Fee: postcard from the venue of remote measurements



Acknowledgement

Financial support highly appreciated:

CTU RVO68407700, SGS 17/138/OHK4/2T/14, GAČR GA18-02482S, EU funds CZ.02.1.01/0.0/0.0/16_019/0000778 and CZ.02.2.69/0.0/0.0/16_027/0008465, IAEA F13019, FUSENET and EUROFUSION.

Students, teachers, technicians (random order):

Vladimír Fuchs, Ondřej Grover, Jindřich Kocman, Tomáš Markovič, Michal Odstrčil, Tomáš Odstrčil, Gergo Pokol, Igor Jex, Gabriel Vondrášek, František Žáček, Lukáš Matěna, Jan Stockel, Jan Mlynář, Jaroslav Krbec, Radan Salomonovič, Vladimír Linhart, Kateřina Jiráková, Ondřej Ficker, Pravesh Dhyani, Juan Ignacio Monge-Colepicolo, Jaroslav Čerovský, Bořek Leitl, Martin Himmel. Petr Švihra, Petr Mácha, Vojtěch Fišer, Filip Papoušek, Sergei Kulkov, Martin Imříšek.

Thank you for your attention

Tokamak TM1
@Kurchatov Institute near Moscow
~1960-1977

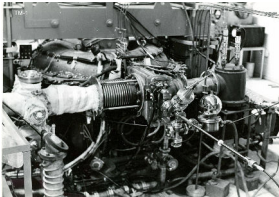

SCIENCE

Tokamak CASTOR
@Institute of Plasma Physics, Prague
1977-2007



SCIENCE
& education

Tokamak GOLEM
@Czech Technical University, Prague
2007-

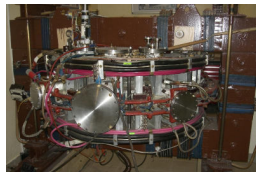

EDUCATION
& science

... with the biggest
control room
in the world ..

Tokamak Golem **REMOTE**** for MASTER (Level 1)**
The smallest & oldest operational tokamak with the biggest control rooms in the world

Home	Wiki	Control Room	Queue	Live	Results	GOLEM Diagram	Chamber status	IP cameras	3D model	Chat	Feedback	Stop
------	------	--------------	-------	------	---------	---------------	----------------	------------	----------	------	----------	------

LEVEL 1

Preionization (electron gun)
Proton
Toroidal magnetic field
Current drive
Vacuum island
GAS handling
Working Gas
Discharge comment
Place the discharge setup into the queue.



Table of Contents

- 1 Introduction
- 2 The Tokamak (GOLEM)
- 3 The Tokamak GOLEM (remote) operation
- 4 The Electron energy confinement time calculation (rough estimation)
- 5 Conclusion
- 6 Appendix**

References I

-  **Wikipedia contributors.** Golem — Wikipedia, the free encyclopedia. <https://en.wikipedia.org/w/index.php?title=Golem>, 2020. [Online; accessed 29-March-2020].
-  **Wikipedia contributors.** Lawson criterion — Wikipedia, the free encyclopedia. https://en.wikipedia.org/w/index.php?title=Lawson_criterion&oldid=888000448, 2019. [Online; accessed 6-December-2019].
-  **ITER contributors .** ITER. <https://www.iter.org>, 2007. [Online; accessed 21-December-2018].
-  **Tokamak GOLEM contributors.** Tokamak GOLEM at the Czech Technical University in Prague. <http://golem.fjfi.cvut.cz>, 2007. [Online; accessed March 7, 2024].

References II

-  Brotankova, J. *Study of high temperature plasma in tokamak-like experimental devices*. PhD thesis, 2009.
-  J. Wesson. *Tokamaks*, volume 118 of *International Series of Monographs on Physics*. Oxford University Press Inc., New York, Third Edition, 2004.
-  V. Svoboda, B. Huang, J. Mlynar, G.I. Pokol, J. Stockel, and G. Vondrasek. Multi-mode Remote Participation on the Golem Tokamak. *Fusion Engineering and Design*, 86(6-8):1310–1314, 2011.