

Instructions for student measurements on the GOLEM tokamak

Dr. Gergo Pokol⁽¹⁾, Laszlo Horvath⁽¹⁾, Csaba Buday⁽¹⁾, Daniel Imre Refy⁽¹⁾

⁽¹⁾ *Department of Nuclear Techniques, Budapest University of Technology and Economics, Association EURATOM, Műegyetem rkp. 3-9., H-1111 Budapest, Hungary*

Last update: October 8, 2012

Abstract

The instructions present a 6 hour long measurement program making use of the remote measurement potential of the GOLEM tokamak located at the Faculty of Physical and Nuclear Engineering of the Czech Technical University (CTU). The purpose of the measurement is to demonstrate the very basics of tokamak operation, and to get the students acquainted with basic properties and operational limits.

1 Introduction

Participants of the present student measurement are strongly encouraged to read chapters 1 and 3 of John Wesson's The science of JET [1] to be downloaded from

<http://www.iop.org/Jet/fulltext/JETR99013.pdf>.

This reading gives an introduction to the basic concept of thermonuclear fusion and magnetic confinement.

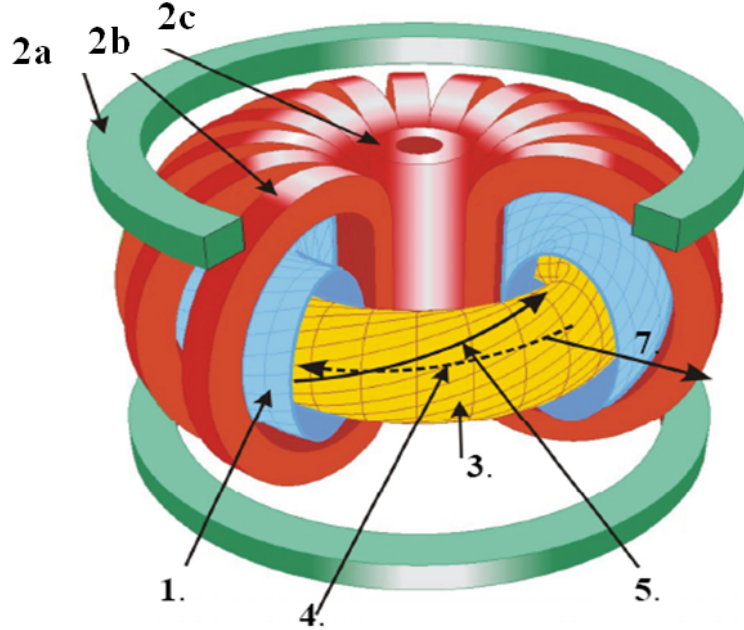

Figure 1: Structure of a tokamak: (1) vacuum chamber, (2a) poloidal field coil / vertical field coil, (2b) toroidal field coil, (2c) transformer coil, (3) plasma, (4) plasma current, (5) magnetic field line, (7) radial direction (r).

Basic build up of a tokamak can be seen on Figure 1. The confining magnetic field structure is the result of the superposition of the toroidal magnetic field (B_t) generated by external coils and the poloidal magnetic field (B_p) generated by a strong toroidal plasma current (I_{pl}) induced by the transformer coil.

In the resulting magnetic geometry, field lines are winding helically around a torus surface, which is called the magnetic surface. The tokamak magnetic field consists of such nested magnetic surfaces. The helical structure at each magnetic surface is described by the safety factor (q). It gives the number of toroidal turns necessary for the magnetic field line at the given magnetic surface to reach its original position poloidally. On large aspect ratio circular tokamaks (like GOLEM), where the major radius (R) is much larger than the minor radius (r_0), it can be approximated by:

$$q(r, t) = \frac{r}{R} \frac{B_t(t)}{B_p(r, t)}, \quad (1)$$

where R is the major radius of the magnetic axis. An illustration for the meaning of the safety factor can be seen on Figure 2.

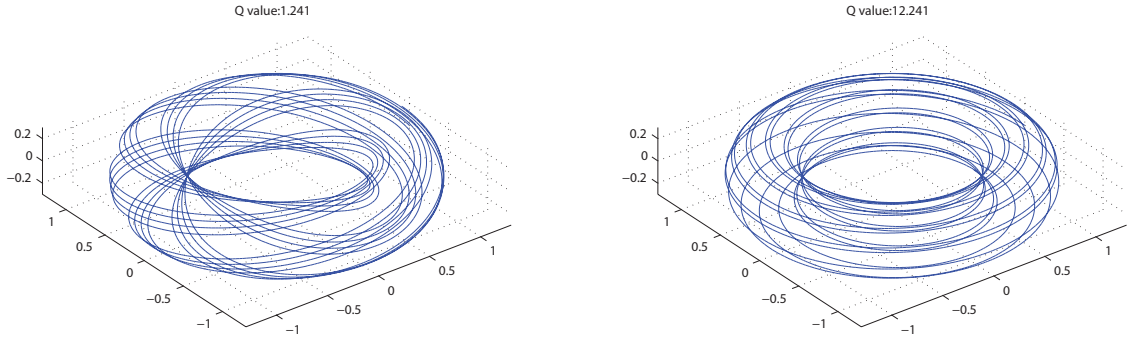

Figure 2: Magnetic field lines in a tokamak for different safety factors.

An important concept regarding the energy balance of the tokamak fusion reactor is the energy confinement time (τ_E). It is the characteristic time of energy loss:

$$P_{loss} = \frac{W_{pl}}{\tau_E}, \quad (2)$$

where P_{loss} is the power lost and W_{pl} is the total plasma energy. The energy confinement time is a global parameter of the confined plasma, and reaching higher values is of central interest of tokamak research.

The Lawson criterion is a simple threshold for self-sustained thermonuclear fusion plasma burn at optimum temperature, and it also includes the energy confinement time along with plasma density (n):

$$n\tau_E > 10^{20} \text{ sm}^{-3}. \quad (3)$$

More general information on fusion power production and the tokamak concept can be found at the following sites: <http://www.magfuzio.hu>, <http://www.iter.org>, <http://www.jet.efda.org/>

1.1 GOLEM

The GOLEM tokamak is a tokamak with full remote control capability and educational purpose. It is a small sized tokamak device equipped with basic controls and diagnostics having dimensions:

- Major radius at the magnetic axis: $R_0 = 0.4$ m.
- Minor radius: $r_0 = 0.1$ m.
- Radial position of the limiter: $a = 0.085$ m.

The device was originally called TM1. Designed and constructed in Kurchatov Institute of Nuclear Research (Soviet Union), it was one of the first operational tokamaks in the world. The original concept of the device did not include poloidal field coils of stabilization however, it was believed that integrating one more layer of vacuum into the chamber would help to achieve better stability of plasma column. The capacitor battery for toroidal field coils and transformer filled several rooms.

Some time later, there was a microwave heating system integrated and the device was renamed to TM1-MH. The microwave heating, in addition to ohmic heating had to heat the plasma further.

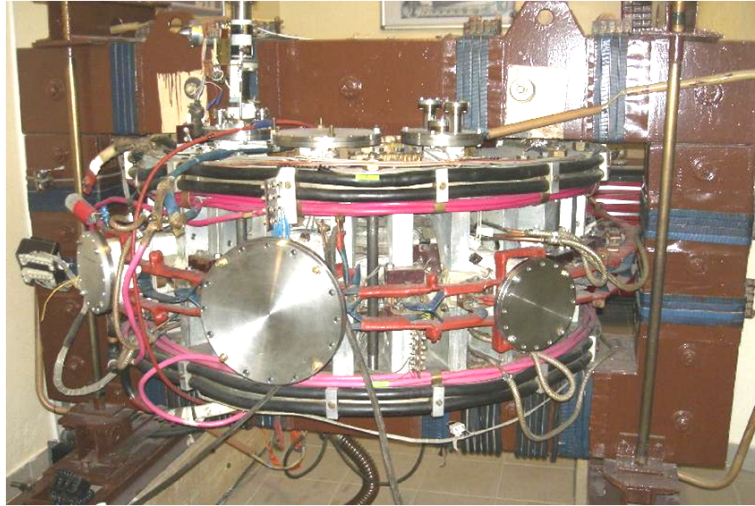

Figure 3: Photo of the GOLEM tokamak

After the device was moved to Institute of Plasma Physics, Czech Academy of Sciences (IPP CAS) in September 1977, thanks to cooperation between the Kurchatov Institute and IPP, some changes in the engineering took place. The microwave heating system was left in Russia, alongside with the most of the oil capacitors of the toroidal field generation, since there was not enough room in the new tokamak hall. A few years later, the device went under major reconstruction. The vacuum vessel was replaced for a new one, the layer of vacuum between the liner and coating were fully removed and a feedback stabilization system was integrated instead. The power supply was substituted by a stronger one, and the ignition was replaced by a glow discharge. Between the years 1977 and 2007 there were several small changes over the device, such as the use of new diagnostics sensors.

In the end of 2007 the device was transferred to the Faculty of Physical and Nuclear Engineering of the Czech Technical University (CTU). Work on the reoperation started on the 14th of July 2008 with limited capabilities, and improvements are still underway. Further upgrade of GOLEM is envisaged in a near future - an increase of B_t , I_p and the discharge duration. Dynamic plasma position stabilization is under present consideration and investigation. Basic diagnostics will be enriched with the plasma density measurement (microwave interferometer), H_α and X-ray radiation measurement will be installed in a near future. Investigation of plasma edge physics with the help of the various probe measurements is planned, as the previous version of the GOLEM tokamak, the CASTOR had a very good inspiring tradition in this field of interest.

More information can be reached via the home site of the GOLEM tokamak:

<http://golem.fjfi.cvut.cz>

Detailed experimental arrangement can be seen at the following link (*This should be studied in detail before the measurement!*):

<http://golem.fjfi.cvut.cz/?p=tokamak>

The parameters to be set remotely:

- Toroidal magnetic field (B_t) through the voltage of the toroidal field capacitor bank ($U_B = U_{C_{Bt}}$), range: 400 – 1400 V.

- Toroidal electric field (E_t) through the capacitor bank for the current drive ($U_E = U_{CD}$), range: 100 – 600 V.
- The time delay between the triggers of the toroidal magnetic field and the current drive ($T_{CD} = \tau_{OH}$), range: 0 – 20000 μ s.
- Hydrogen gas pressure (p_{H_2}), range: 0 – 100 mPa.
- Preionization ON/OFF

Figure 4 shows the effect of time delay parameter.

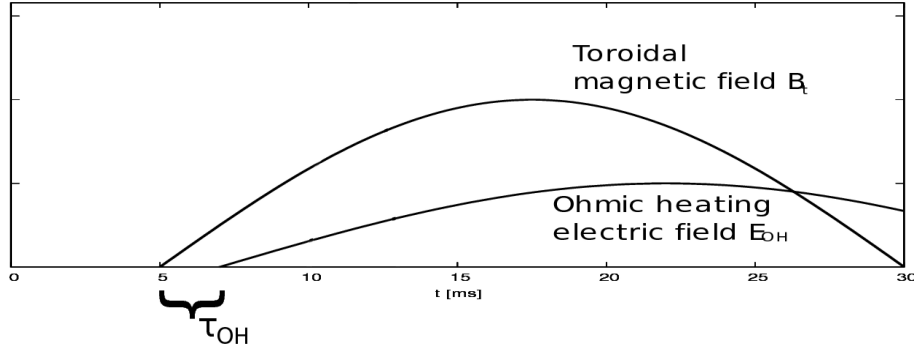

Figure 4: Time delay parameters.

The diagnostics used during the session to be accessed online:

- Time resolved measurement of loop voltage (U_l).
- Time resolved measurement of total toroidal current by Rogowski coil (I_t).
- Time resolved toroidal magnetic field by coil measurement (B_t).
- Time resolved measurement of plasma radiation by photodiode.
- Vacuum chamber pressure (p_{ch}).
- The temperature of the vacuum chamber (T_{ch}).

2 Measurement procedure

This section summarizes the technical procedures necessary for the remote control of the GOLEM tokamak.

2.1 Communication with local support

Primary real time communication to the local support (Dr. Vojtech Svoboda) is through Skype instant messaging. For this purpose a user (name: nti.hallgato, passwd: vendeg0 or name: nti.hallgato2, passwd: vendeg1) has been created. Before starting the experiment an instant messaging conference is to be started including users nti-hallgato, gergo_pokol (Dr. Gergo Pokol, Hungarian supervisor) and tokamak.golem (Dr. Vojtech Svoboda, Czech support). After the session the conversation log should be saved and appended to the measurement log.

2.2 Remote control

Measurements are to be set up and shots initiated using the web interface of GOLEM tokamak, which can be seen on figure 5. The exact url address of it is provided by Dr. Vojtech Svoboda just at the beginning of the session.

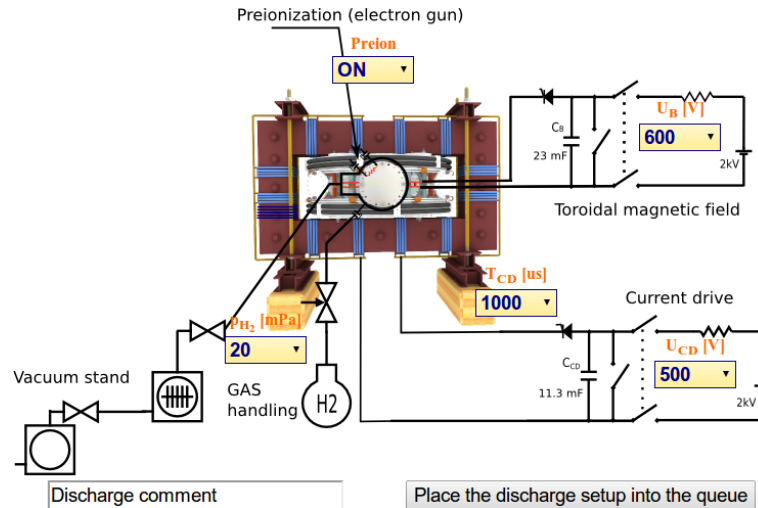

Figure 5: Remote control interface of GOLEM tokamak.

2.3 Remote data access

All the recorded data and the settings for each shot are available at the GOLEM website. The root directory for the files is:

<http://golem.fjfi.cvut.cz/operation/shots/<shotnumber>/>

Basic data of the present shot series are collected at a page to be reached at:

<http://golem.fjfi.cvut.cz/operation/currentsession/>

during the session and later archived at:

<http://golem.fjfi.cvut.cz/operation/tasks/Practica/BudapestBME-NTI/>

In order to facilitate the procedure of data analysis, a MATLAB package is available for basic data processing. (This package is also compatible with the OCTAVE freeware software.) The task is to build a proper work flow using these building blocks. It should be noted that these routines do not cover the whole procedure, some additional programs are supposed to be written by the students. The routines are listed in the Table below:

File name	Input parameters	Description
GOLEM_get_data.m	shot_nr	Loads raw data from database into the MATLAB workspace
GOLEM_plot_rawdata.m	shot_nr	Makes plots of the time varying raw data
GOLEM_offset_correction.m	raw_signal, time_vector, t1,t2	Makes offset correction for raw data
GOLEM_cut_data.m	raw_signal, time_vector, t1,t2	Crop the given signal
GOLEM_integrate.m	time_vec, signal	Integrates the given signal
GOLEM_chamber_current.m	time_vec, I_t, U_l, R_{ch}, L_{ch}	Calculates chamber current integrating equation (7)
GOLEM_diff.m	x, y	Calculates dx/dy

GOLEM_get_data.m The return value of GOLEM_get_data.m contains then **rawdata** structure with the following elements:

- **nr:** shotnumber
- **timedata:** structure, contains vectors of time signals
 - **U_l:** loop voltage measurement raw signal vector in [V]
 - **dB_t:** toroidal filed coil raw signal vector in [V]
 - **dI_t:** Rogowski coil raw signal vector in [V]
 - **Photo:** photodiode raw signal vector in [V]
- **N:** number of data points
- **samplerate:** samplerate of the measurements in [Hz]
- **pressure:** pressure of vacuum chamber in [mPa]
- **T_ch:** temperature of the chamber in [K]
- **trigger:** time delay between starting diagnostics and toroidal magnetic field drive in [s]
- **time_delay:** time delay between toroidal field and inductive current drive in [s]
- **Bt_calibration:** calibration factor of toroidal magnetic field diagnostic in [T/Vs]
- **Rogowski_calibration:** calibration factor of plasma current diagnostics in [A/Vs]
- **U_loop_calibration:** calibration factor of loop voltage diagnostic [V/V]

Elements of structures can be referenced as e.g. **rawdata.timedata.U_l**. *Measured signals are saved in the timedata structure, but these are raw signals needing further processing to produce the physical quantities measured!* Signal processing steps are described in the next section.

3 Measurement tasks, method of evaluation

This section starts with a short description on how to reconstruct the measured plasma parameters from the rwa signals returned by GOLEM_get_data.m. Measurement tasks are detailed in the later subsections.

The sampling rate of the time resolved measurements (samplerate), time delay between starting diagnostics and toroidal magnetic field drive (trigger) and time delay between toroidal field and inductive current drive (time_delay) are returned by GOLEM_get_data.m, and these are to be used whenever needed instead of the examples provide in this description.

The simplest signal to be reconstructed is the loop voltage (U_l): The measurement loop of the loop voltage is connected to a voltage divider, therefore the signal must be multiplied by a calibration factor (U_loop_calibration) as plotted in Figure 6.

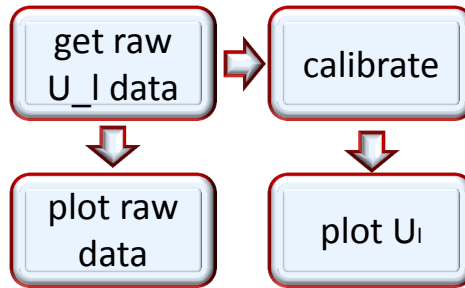

Figure 6: Block diagram showing the steps of data processing for loop voltage measurement.

The toroidal magnetic field (B_t) and the total current (I_{tot}) raw signals must be integrated before multiplying by calibration factors (Bt_calibration and Rogowski_calibration). The reason for this is that the voltage measured is induced in these diagnostic loops and coils by the changing of the toroidal and poloidal magnetic field respectively.

Integrated magnetic measurements are very sensitive to the DC bias of the measurement circuit, which needs to be corrected for. If the sampling rate is 1 MHz, and the shot starts at 5 ms, we have 5000 samples from the background noise. It is better to exclude a few samples around the swithing time point. This is important, because these samples measure the bias, and we can correct the integrated values with this factor.

Figure 7 shows the block diagram for the necessary steps of processing for the toroidal magnetic field signal. Routines for all the steps are ready, they should just be parametrized and linked.

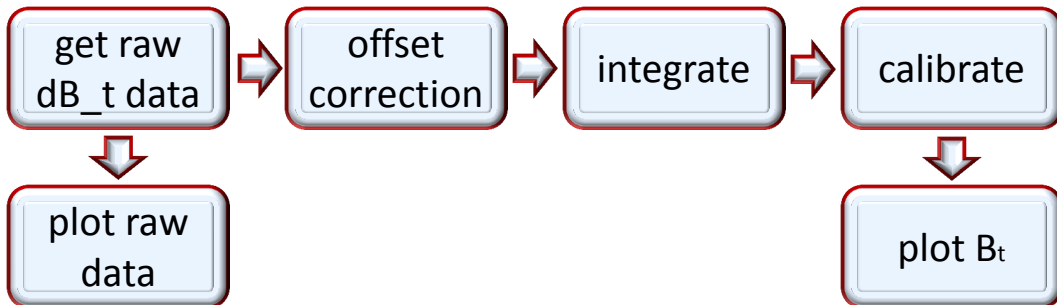

Figure 7: Block diagram showing the steps of data processing for toroidal magnetic field measurement.

The block diagram for the total current measured by the Rogowski coils is only slightly more complicated: Switching the toroidal magnetic field on causes an offset in the toroidal current measurement, which has to be corrected by subtracting the average value measured in the τ_{OH} long interval before switching on the toroidal electrical field from the integrated current value.

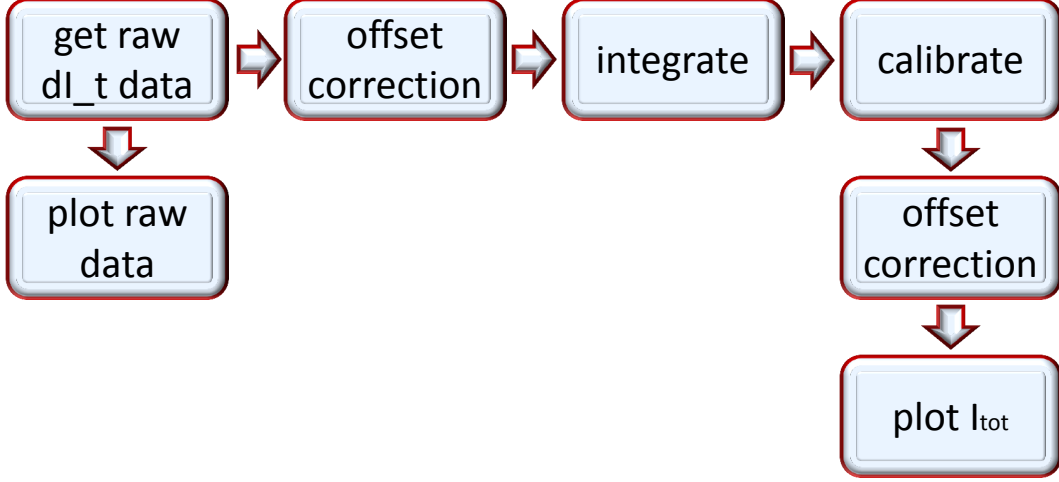

Figure 8: Block diagram showing the steps of data processing for total plasma current measurement.

3.1 Determination of vacuum chamber parameters

In GOLEM, part of the toroidal current always flows in the vacuum vessel, which has to be taken into account during the interpretation of experimental results. In a vacuum shot, when no plasma is formed, it is possible to determine the resistance of the vacuum vessel: all the current measured by the Rogowski-coil flows in the vessel. This is an important parameter for further evaluations.

Let us denote the loop voltage with U_l , the resistance of the chamber by R_{ch} , the total current (which is the chamber current (I_{ch}) in this case) with I_{tot} and the inductance of the chamber by L_{ch} .

The circuit equation is then

$$U_l(t) = R_{ch} \cdot I_{tot}(t) + L_{ch} \frac{dI_{tot}}{dt}. \quad (4)$$

Using the loop voltage measurement and the Rogowski-coil, we have both U_l , I_{tot} and dI_{tot}/dt measured, so R_{ch} and L_{ch} can be determined.

A simple method is the following: Just after switching on the toroidal electric field, the toroidal current is still close to zero ($I_{tot} \approx 0$), so $U_l \approx L_{ch} dI_{tot}/dt$, so L_{ch} can be determined. On the other hand, at the flat top of the current curve ($dI_{tot}/dt \approx 0$) equation (7) simplifies to $U_l \approx R_{ch} \cdot I_{tot}$, so R_{ch} can be estimated.

A more sophisticated method is a 2D least squares linear fit making use of all data points ($U_l, I_{tot}, dI_{tot}/dt$). Since we have only two independent parameters R_{ch} and L_{ch} , the fitted plane has to pass through the origin. If we divide equation (7) by I_{tot} , we can simplify the task to a 1D least squares linear fit, which can be easily implemented in MATLAB (OCTAVE), using *polyfit* function.

Values of R_{ch} and L_{ch} should be calculated for about 5 discharges having different parameters, and the results should be compiled to a single best estimate for both parameters. Estimation should

be performed by both methods described above, and the results of the method giving the more precise estimates should be used in the further steps.

3.2 Plasma breakdown

After measuring the vacuum chamber properties, we can make the next step towards creating a tokamak plasma: we can let H_2 gas into the chamber before initiation of the toroidal electric field. The p_{H_2} value, which can be set as a discharge parameter, is a control parameter for the inlet valve. The actual value of the pre-discharge gas pressure is measured by a vacuummeter p_{ch} .

As we will see, letting H_2 gas into the chamber is not always sufficient to produce a plasma. The toroidal electric field must also reach a critical value for mass ionization, in other words plasma breakdown.

The task is to plot the p_{ch} against the maximum of the loop voltage spikes in the beginning of the discharge for several discharges, and indicate the plasma breakdown by the shape of the symbols. Shots should be concentrated around the critical line separating breakdown and non-breakdown shots. Detailed scan should be performed for a given magnetic field and the effect of the magnetic field should be studied with a few discharges. During this exercise the pre-ionization should be turned on to produce more reproducible results, but the effect of turning it off could also be studied. About a total of **30** discharges are available for this exercise.

3.3 Estimation of main plasma parameters

If plasma breakdown occurs, plasma parameters can be determined - with different accuracy - from the measured parameters. The aim of this task is to investigate the effect of different parameters on the performance of the discharge, and reach discharges with the highest central temperature, plasma energy or energy confinement time. This task should result in about **25** discharges.

3.3.1 Plasma current

A simple electrical model for the inductive current drive is a time-varying voltage source ($U_l(t)$) connected to the plasma and the vacuum chamber in parallel can be seen on Figure 9. Both the vacuum chamber and the plasma are modeled by LR circuits. The main difference is, that while the internal inductance and resistance of the chamber are constant, and thus they can be measured separately, the parameters of the plasma differ in each discharge.

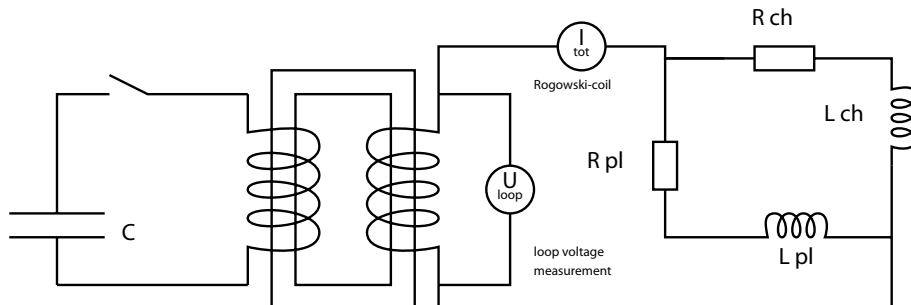

Figure 9: Model of the inductive current drive circuit

The basic circuit equations are:

$$U_l(t) = R_{ch} \cdot I_{ch}(t) + L_{ch} \frac{dI_{ch}(t)}{dt} \quad (5)$$

$$U_l(t) = R_{pl}(t) \cdot I_{pl}(t) + L_{pl} \frac{dI_{pl}(t)}{dt} \quad (6)$$

$$I_{tot}(t) = I_{pl}(t) + I_{ch}(t) \quad (7)$$

The chamber parameters have already been determined according to Section 3.1. Integration of the (8) circuit equation using the initial condition $I_{tot}(t = 0) = I_{ch}(t = 0)$ is implemented in the routine `GOLEM_chamber_current.m` to arrive to $I_{ch}(t)$. This can then be used to determine the plasma current, as $I_{pl}(t) = I_{tot}(t) - I_{ch}(t)$ as shown in Figure 10. Plasma resistivity can be determined in turn from equation (9).

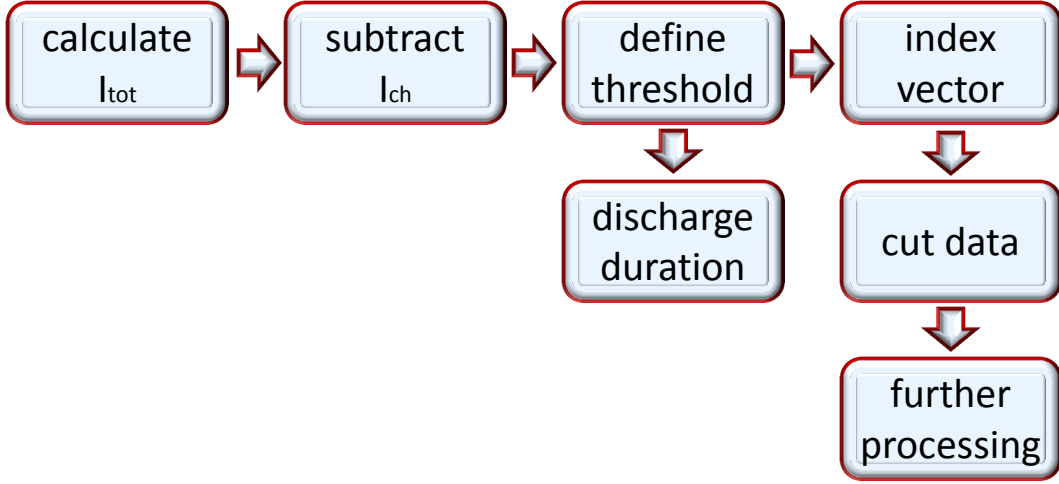

Figure 10: Block diagram showing the steps of data processing for the plasma current measurement.

Having calculated the plasma current, a threshold can be defined significantly exceeding the calculation accuracy to safely determine the beginning and end of the plasma discharge. Using this threshold in the "find" function, one can cut the time signals to the extent of the discharge for further processing. Time duration of the discharge is also an important parameter.

This task needs some programming that should be done parallel to the task described in Section 3.2!

It can be attempted to investigate the effect of the $L_{pl} \approx 0$ H approximation by a more careful integration of choosing $L_{pl} \approx L_{ch}$ in the time region with plasma. If significant differences are found, this latter approximation has to be implemented for all further data processing.

A suitable threshold in plasma current can be used to determine the discharge duration and cut out the interval of the measured signals relevant for plasma diagnostics.

Plasma current has to be calculated for all discharges with plasma and the maximum value and the discharge duration have to be included in the shot summary table.

3.3.2 Plasma heating power

In the GOLEM tokamak the only heating mechanism of the plasma is ohmic heating resulting from current flowing in a conductor with finite resistivity. The ohmic heating power can be calculated as:

$$P_{OH}(t) = R_{pl}(t) \cdot I_{pl}^2(t) \quad (8)$$

Ohmic heating power has to be calculated for all discharges with plasma and the maximum value has to be included in the shot summary table.

3.3.3 Central electron temperature

Specific resistivity of a fully ionized plasma only depends on its electron temperature (T_e) and effective charge number (Z_{eff}). This dependence is quantified by the Spitzer formula [2]. It has to be noted that the ion temperature can be very much different from electron temperature. The effective charge number is determined by the amount, composition and state of impurities in the H_2 plasma, and we can take value $Z_{eff} \approx 2.5$ for GOLEM plasmas.

Center of the plasma has higher temperature, and lower resistivity with higher current density, which makes the estimation of the electron temperature ambiguous from an integrated value of resistivity ($R_{pl}(t)$). However, if we use an equilibrium temperature profile (12) (Figure 11), measured in more detailed measurements [3], we can estimate one parameter of the profile, which is in this case the central electron temperature ($T_{e0}(t)$):

$$T_e(r, t) = T_{e0}(t) \left(1 - \frac{r^2}{a^2}\right)^2 \quad (9)$$

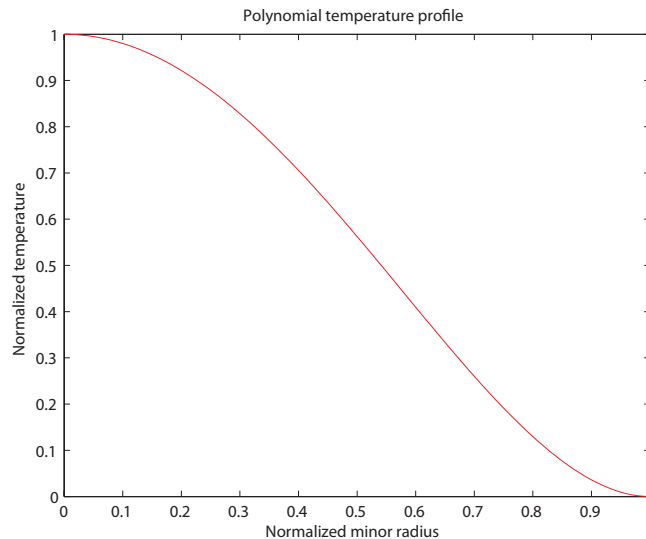

Figure 11: Equilibrium temperature profile used in the estimation of central plasma temperature

The central electron temperature (T_{e0}) is then calculated from equation (3.20) of [3], which itself is based on Spitzer's resistivity formula:

$$T_{e0}(t) = \left(\frac{R_0}{a^2} \frac{8Z_{eff}}{1544} \frac{1}{R_{pl}(t)}\right)^{2/3}, \quad (10)$$

where $R_{pl}(t)$ is in Ohms, distances are in meters and we get $T_{e0}(t)$ in electronvolts.

It has to be noted that plasma in the GOLEM tokamak is only fully ionized in the central region, Z_{eff} can be estimated with large uncertainty and even the a plasma small radius might change in an unmonitored way due to the lack of plasma stabilization. All these factors make the estimation of the central electron temperature quite uncertain.

Nevertheless, central electron temperature has to be calculated for all discharges with plasma and the maximum value has to be included in the shot summary table.

3.3.4 Electron density

In its current state, the GOLEM tokamak does not have any density measurements. However, as electron density is needed for further calculations, we estimate its order of magnitude from the state law of ideal gases.

For the average density it is assumed, that it is constant during the discharge, apart from the dissociation of the hydrogen gas. There is a 30 second delay between the gas filling and the actual shot, which is enough for the gas to reach thermal equilibrium with the chamber wall. Chamber temperature is monitored with respect to the room temperature, and the difference is normally be zero, but should be checked. (If chamber temperature is not measured, room temperature can be used instead.) The ideal gas law is used to give an order of magnitude estimate of the electron density (in particle/ m^3):

$$n_{avr} = \frac{2p_{ch}}{k_B T_{ch}}. \quad (11)$$

We have to note that this is a very rough estimate basically for two reasons:

1. Plasma in the GOLEM tokamak is not fully ionized, which makes us overestimate the electron density.
2. Due to the plasma-wall interaction, adsorbed gases are released from the surface of plasma facing components during the discharge. These atoms enter the plasma and can be ionized, thus making us underestimate the electron density.

The order of magnitude estimate of the average electron density has to be calculated for all discharges with plasma and included in the shot summary table.

3.3.5 Plasma energy

The total energy content can be simply calculated from the temperature, density and volume (V), based on the ideal gas law, taking into account the assumed (12) temperature profile:

$$W_{pl}(t) = V \frac{n_{avr} k_B T_{e0}(t)}{3}. \quad (12)$$

The information that the magnetic field reduces the degrees of freedom of the particles to two has been used to derive this formula.

Uncertainty of this formula is dominated by the uncertainty of our density estimate, which makes it good only for an order of magnitude estimate. Qualitative time trace reflects that of the electron temperature and thus is more reliable.

Nevertheless, plasma energy has to be calculated for all discharges with plasma and the maximum value has to be included in the shot summary table.

3.3.6 Energy confinement time

Having an estimate for the plasma energy, the energy confinement time can be estimated. The loss power can be estimated from the energy balance:

$$P_{loss}(t) = P_{OH}(t) - \frac{dW_{pl}}{dt} \quad (13)$$

We then have to just substitute it into the definition (2) of the energy confinement time:

$$\tau_E(t) = \frac{W_{pl}(t)}{P_{loss}(t)}. \quad (14)$$

Given the uncertainty of the input parameters, maximum value for the energy confinement time should be taken with care. Nevertheless, its maximum should be included in the shot summary table.

3.4 $q = 2$ disruptions

When the plasma current grows so strong that the edge safety factor, defined by (1), reaches the value of 2, a plasma instability resonant to the $q = 2$ rational surface destabilizes, and a discharge terminating disruption occurs. This limit of operation is to be attempted to be reached in this task using about **5** dedicated shots.

We can calculate the poloidal field at the edge (for large aspect ratio circular tokamaks) using Ampère's law, as the enclosed current is the total plasma current:

$$B_p(a, t) = \frac{\mu_0 I_{pl}(t)}{2\pi a}, \quad (15)$$

where a is the plasma minor radius. Substituting this expression into formula (1), the safety factor at the edge can be estimated as:

$$q(a, t) = \frac{a^2 2B_t(t)\pi}{R_0 \mu_0 I_{pl}(t)}. \quad (16)$$

Discharges aiming to reach a low $q(a, t)$ need as large plasma current as possible. As we have very limited control over the evolution of plasma current in GOLEM, we can also set the τ_{OH} time delay to set up a discharge at the declining phase of the toroidal magnetic field, which will constantly decrease the edge safety factor.

In order to monitor the success of our efforts, the evolution of the discharges should be plotted on the Hugill diagram. The Hugill diagram positions a discharge on the plane of two parameters:

- Inverse edge safety factor: $\frac{1}{q(a, t)}$
- Murakami parameter (normalized density): $\frac{n_{avg} R_0}{B_t(t)}$

The Hugill diagram serves as an operation envelope for tokamaks. If either the Murakami parameter is too high or the inverse edge safety factor reaches the value of 0.5, the plasma disrupts.

First, the temporal evolution of the dedicated shots aiming $q = 2$ disruptions should be plotted on the Hugill diagram. Afterwards, all previous shots could be plotted to check that none reach the region $1/q > 0.5$.

4 Requirements for the measurement logbook

There should be a single measurement log written in English language. The measurement log should include:

- Exact method of executing the measurement.

- Exact method of derivation of final results.
- Results of the measurement tasks.
- Time traces of shot parameters for some characteristic shots.
- Shot summary table indicating all calculated parameters of all shots executed. (Unsuccessful shots also need to be recorded.)
- Skype log as appendix

All comments and proposals regarding the measurements are welcome.

It would be nice, if the participants of the session would write some thankful words to the <http://golem.fjfi.cvut.cz/hodnoceni.html> homepage, and/or send a postcard to the following address: Tokamak GOLEM, Brehova st. 7, Prague 1, Czech Republic. These activities should also be indicated in the logbook.

References

- [1] John Wesson. The science of JET. In *JET Reports*, pages JET-R(99)13. 1999.
- [2] *NRL plasma formulary*. Naval Research Laboratory, 2009.
- [3] Jana Brotánková. *Study of high temperature plasma in tokamak-like experimental devices*. PhD thesis, Charles University in Prague, 2009.