

Foreword

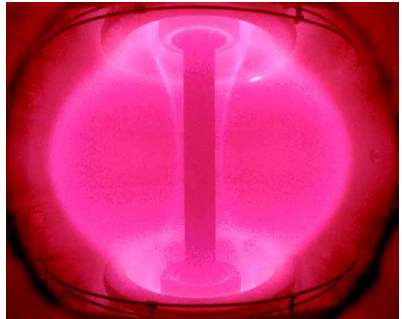

Our mission

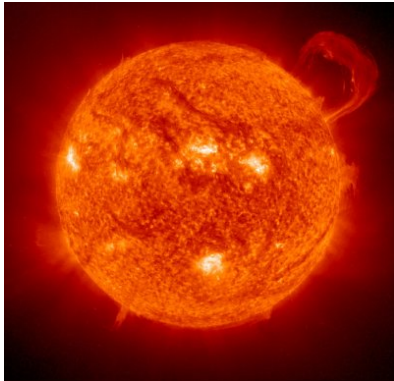
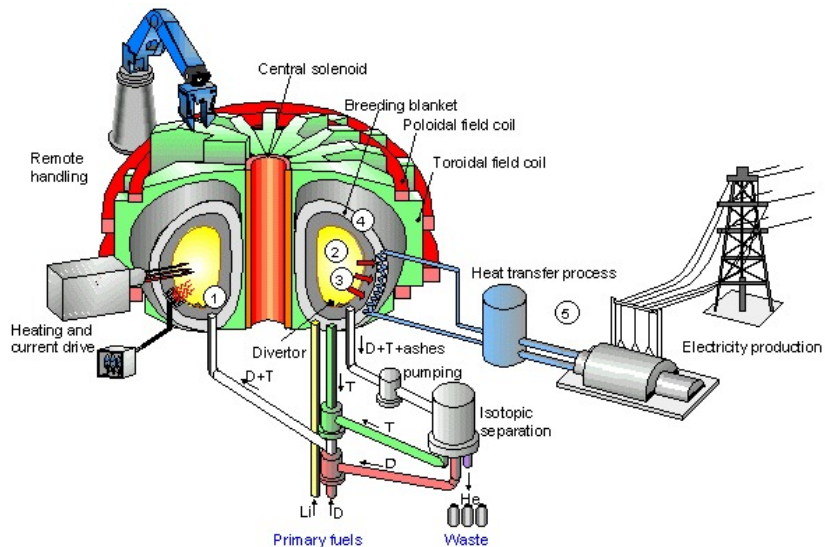

Milestones to Fusion Power Plant

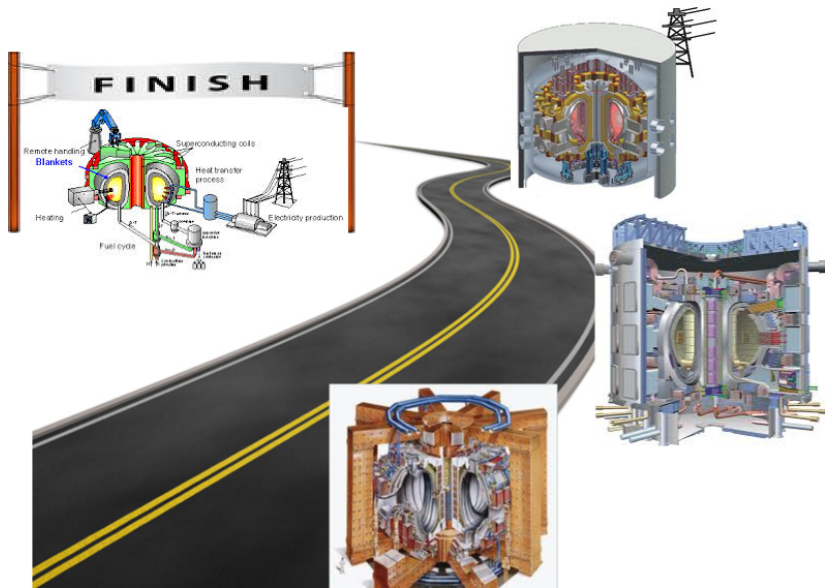

Start with tokamak GOLEM

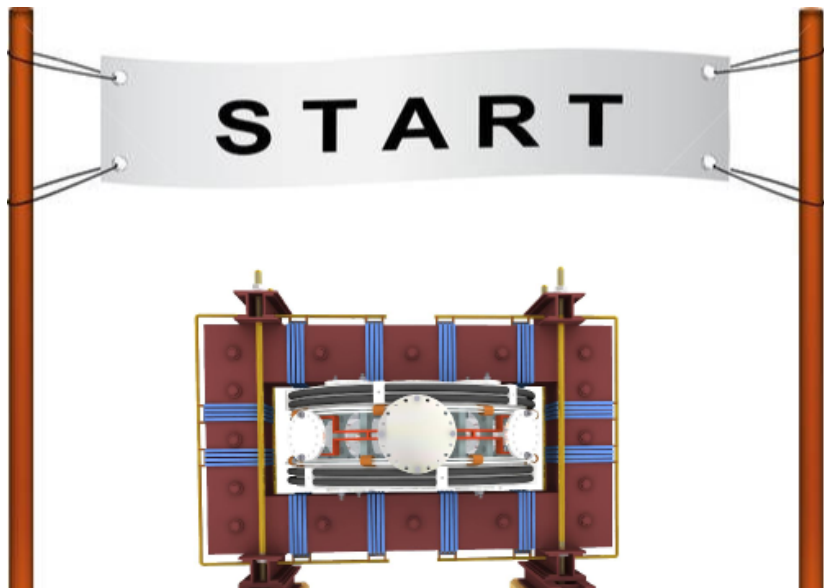

Introduction to tokamak operation
(GOLEM specific) - Level 1

Vojtěch Svoboda
on behalf of the tokamak GOLEM team

February 7, 2014

Outline

- 1 Introduction
- 2 Tokamak GOLEM - engineering scheme
- 3 Tokamak GOLEM - diagnostics
- 4 Data access
- 5 Data manipulation
- 6 Possible tasks
- 7 Conclusion

Basic characteristics

- Major radius $R_0 = 0.4$ m
- Minor radius $r_0 = 0.1$ m
- Plasma radius $a = 0.085$ m
- Toroidal magnetic field $B_t < 0.5$ T
- Plasma current $I_p < 8$ kA
- Plasma density
 $n \approx 0.2 - 3 \times 10^{19}/\text{m}^{-3}$
- Electron temperature $T_e < 100$ eV
- Ion temperature $T_i < 50$ eV
- Length of the discharge $\tau < 20$ ms

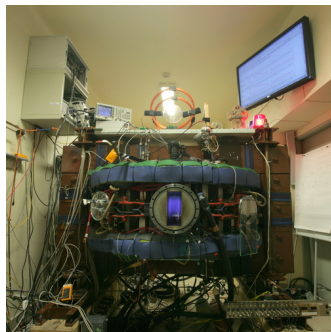

Tokamak GOLEM for education - historical background

Kurchatov Institute near Moscow,
Soviet Union
1960: **TM1-MH**

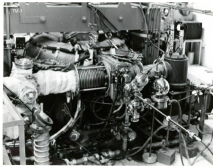

1974



Culham Centre for Fusion Energy
Great Britain
1989: **COMPASS-D**

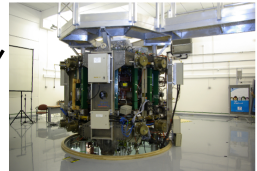

2006



Institute of Plasma Physics
Czech republic
CASTOR **COMPASS**



2008



Czech Technical University Prague
Czech republic
GOLEM



GOLEM



The new location of the tokamak is just next to the old Prague Jewish cemetery where Rabi Loew (Golem builder) is buried, and that is why it was renamed GOLEM (and also for the symbol of potential power you get if you know the magic). Interestingly, here in Prague, where the Golem legend originated, Golem is not perceived as a symbol of evil, but rather as a symbol of power which might be useful but is very challenging to handle. To learn more of the Golem legend, see e.g. [wikipedia](https://en.wikipedia.org/wiki/Golem).

The Golem tokamak - South view (02/12)

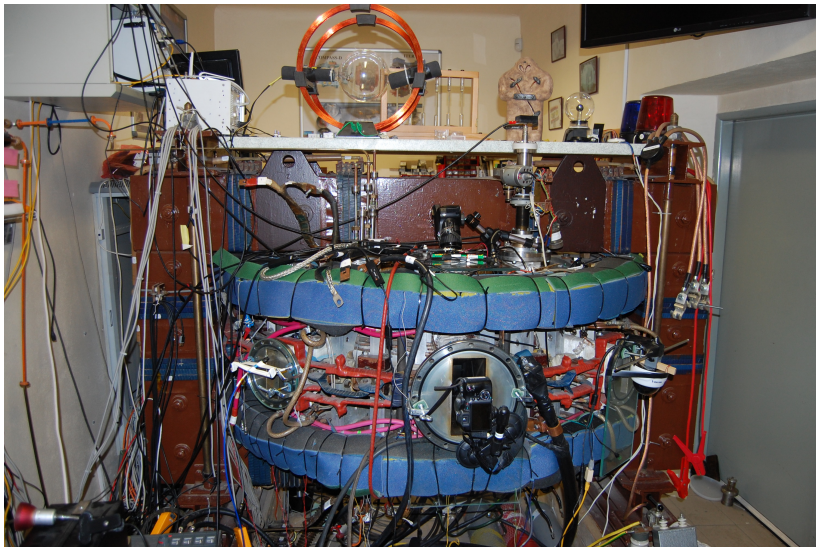

The Golem tokamak - South view (02/12)

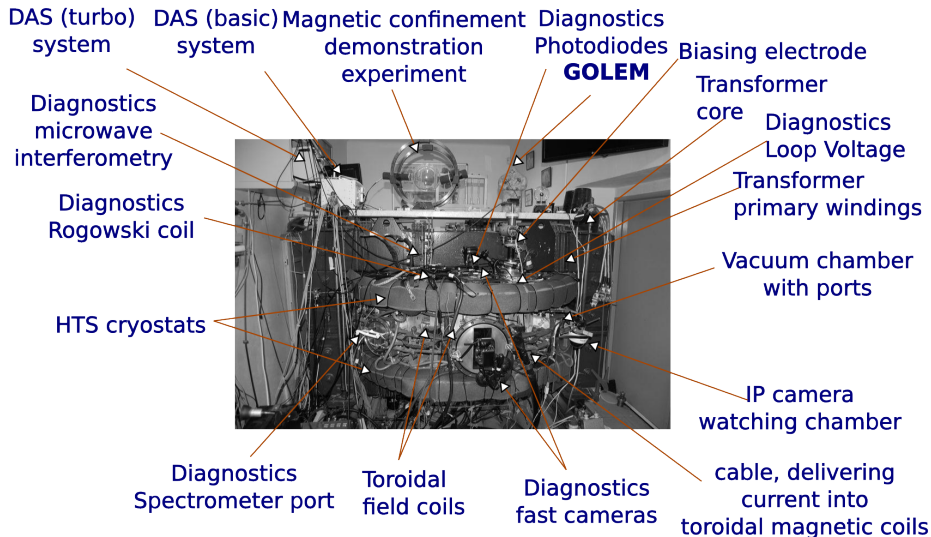

The Golem tokamak - North view (02/12)



The Golem tokamak - North view (02/12)

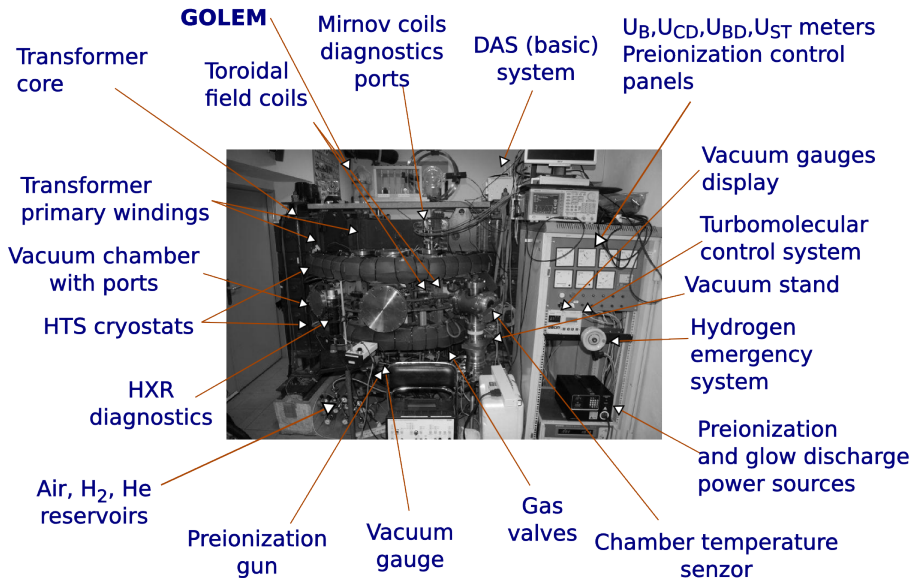

Infrastructure room (below tokamak)



Infrastructure room

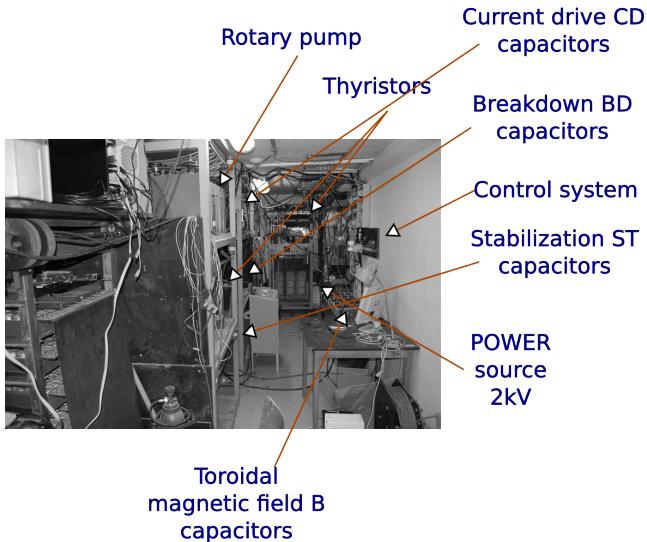

The GOLEM tokamak virtual model

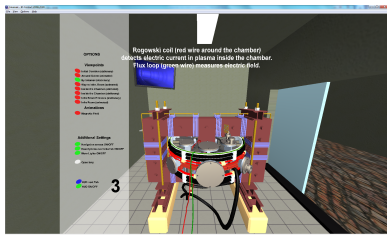

Tokamak Room & Infrastructure Room

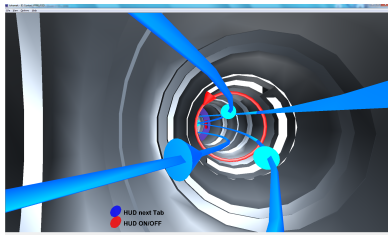
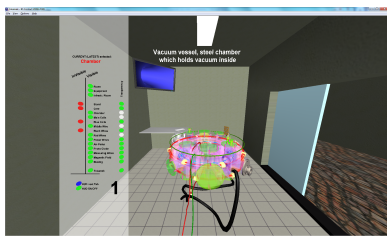

Inner view & Inside chamber

Outline

- 1 Introduction
- 2 Tokamak GOLEM - engineering scheme
- 3 Tokamak GOLEM - diagnostics
- 4 Data access
- 5 Data manipulation
- 6 Possible tasks
- 7 Conclusion

Plasma in Tokamak (GOLEM) - the least to do

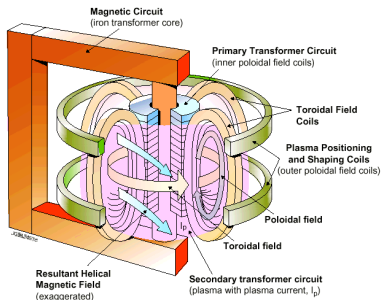

- Evacuate the chamber.
- Fill in the working gas.
- Preionization
- Toroidal magnetic field to confine plasma.
- Toroidal electric field to breakdown neutral gas into plasma.
- Toroidal electric field to heat the plasma.
- Plasma positioning (under construction).
- Diagnostics.

Tokamak GOLEM - engineering scheme

LEVEL 3

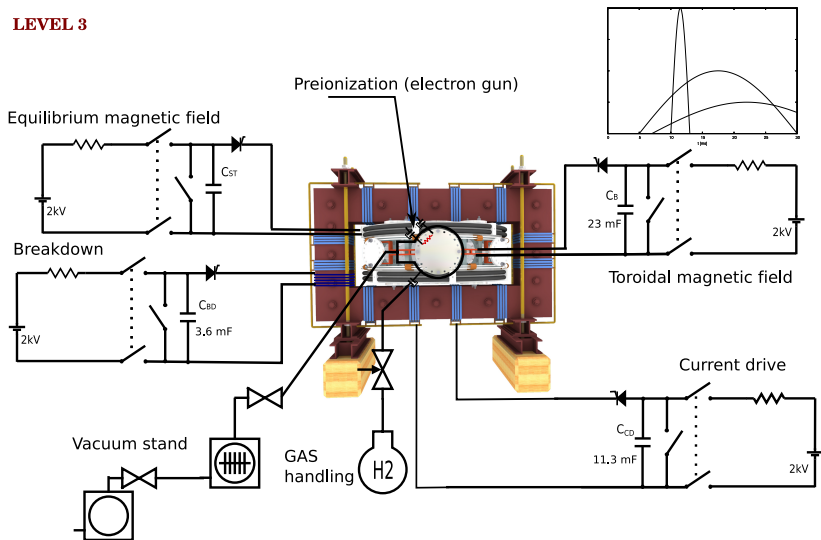

Tokamak GOLEM - basic

LEVEL 0

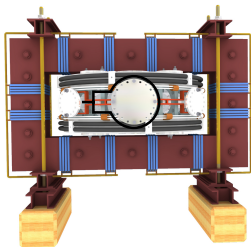

+ vacuum pumping system (100 kPa \rightarrow \approx 1 mPa)

LEVEL 0

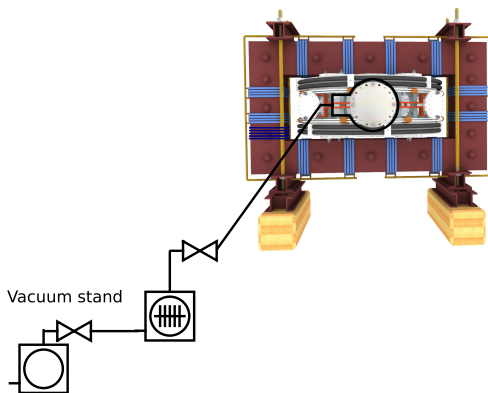

+ working gas management (H_2 or He)

LEVEL 0

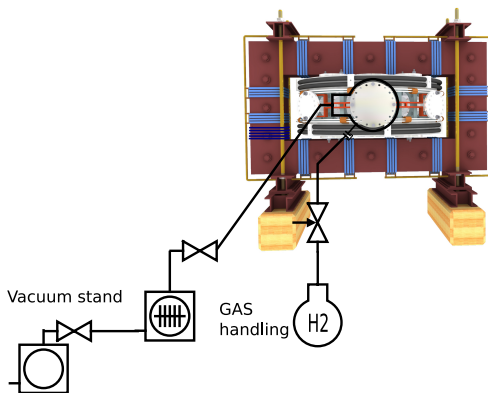

Insertion - LC circuit

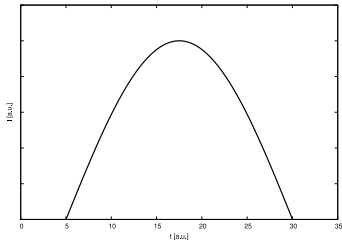
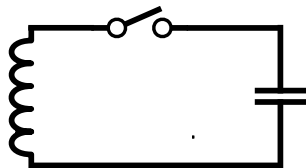
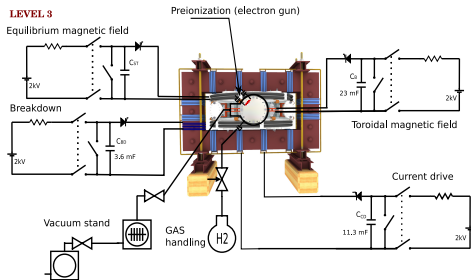

+ toroidal magnetic field B_t .. plasma confinement

LEVEL 1

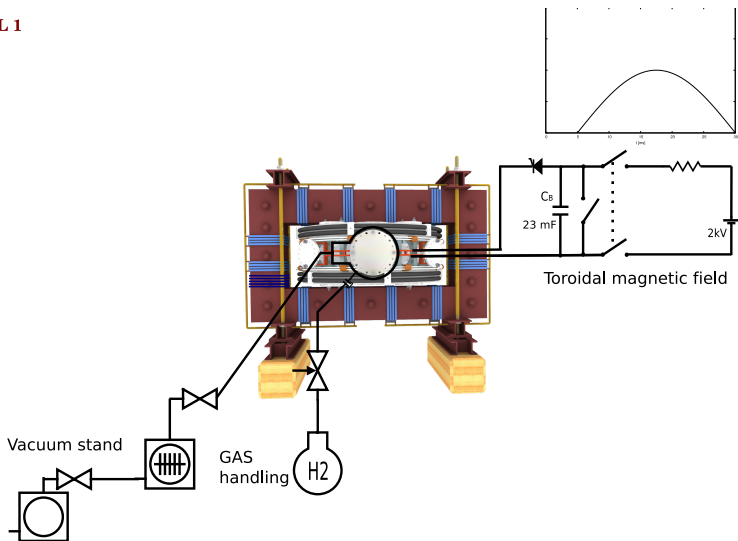

+ toroidal electric field E_{CD} .. plasma heating

LEVEL 1

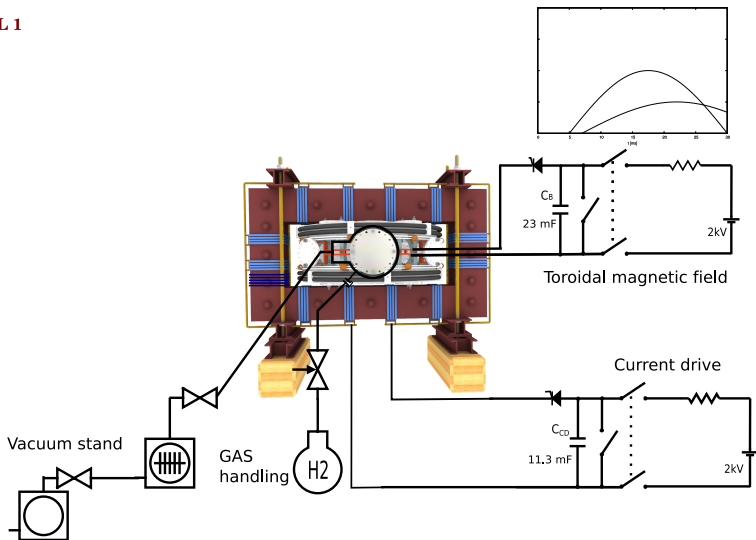

Triggering sequence

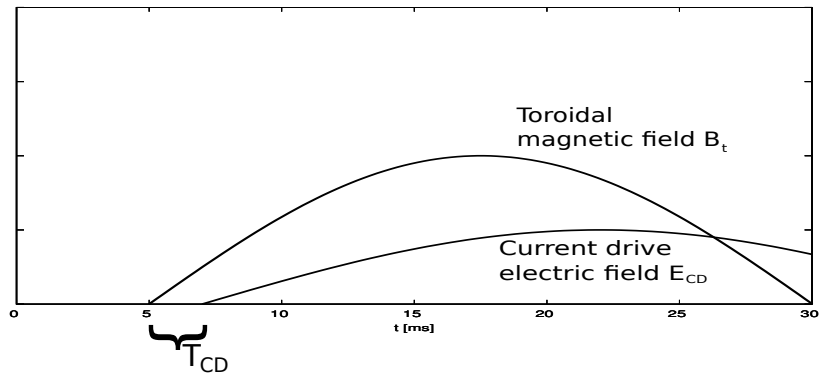

Preionization

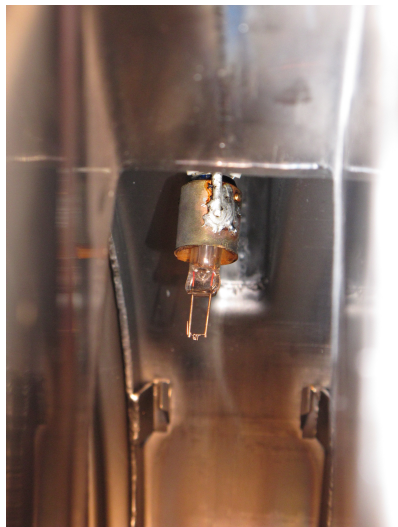
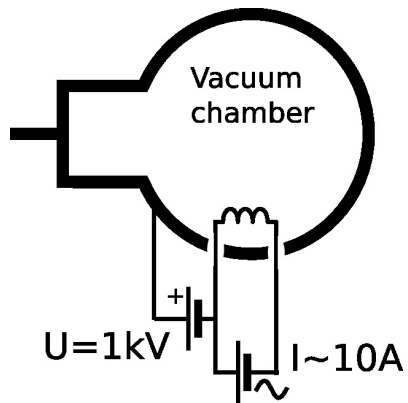

The GOLEM tokamak Control Room - level I

*Tokamak Golem **REMOTE** for MASTER (Level I)*

The smallest & oldest operational tokamak with the biggest control room in the world

Home	Wiki	Control Room	Queue	Live	Results	Golplot	Chamber status	IP cameras	3D model	Chat	Feedback	Level I
------	------	--------------	-------	------	---------	---------	----------------	------------	----------	------	----------	---------

LEVEL I

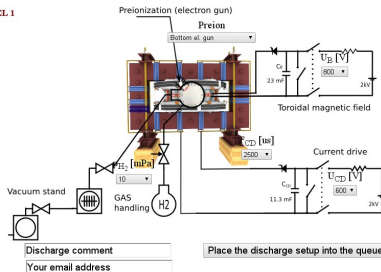

Outline

- 1 Introduction
- 2 Tokamak GOLEM - engineering scheme
- 3 Tokamak GOLEM - diagnostics**
- 4 Data access
- 5 Data manipulation
- 6 Possible tasks
- 7 Conclusion

Basic plasma diagnostics in tokamak GOLEM

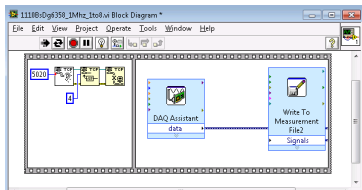

PXI system with PXIe 6358

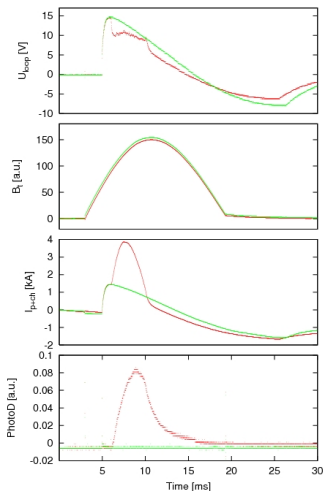
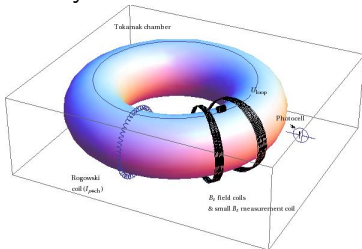

Data Acquisition System based on:



Loop Voltage

Diagnostics: U_{loop} - simple single loop of wire around the tokamak, connected to Data Acquisition System.

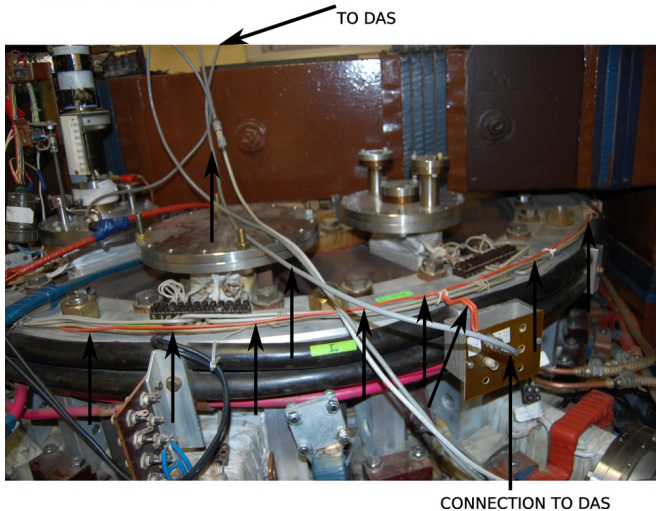

Basic diagnostic - toroidal magnetic field B_t

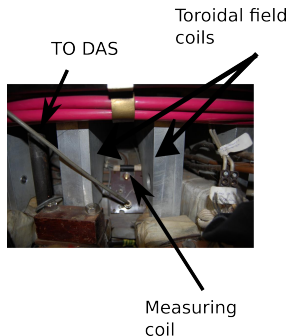

Is deduced from small coil measurements with three operations:

- offset identification from first 4500 data rows).
- time integration (it is a magnetic diagnostic, where $U_{acquired} \sim \frac{dB_t}{dt}$)
- multiplication of **calibration factor** C_{Bt} .

$$\langle U_{offset}^{Bt} \rangle = \frac{1}{4500} \sum_{i=0}^{4500} U_i^{Bt}; B_t \approx C_{Bt} \left(\sum_{i=0}^{40000} U_i^{Bt} \Delta t - \langle U_{offset}^{Bt} \rangle t \right).$$

Basic diagnostic - total current I_{p+ch}



Is deduced from Rogowski coil measurements with three operations:

- offset identification from first 4500 data rows).
- time integration (it is a magnetic diagnostic, where $U_{acquired} \sim \frac{dI_{p+ch}}{dt}$)
- multiplication of calibration factor
calibration factor C_{rog}

$$\langle U_{offset}^{rog} \rangle = \frac{1}{4500} \sum_{i=0}^{4500} U_i^{rog}; I_{p+ch} \approx C_{rog} \left(\sum_{i=0}^{40000} U_i^{rog} \Delta t - \langle U_{offset}^{rog} \rangle t \right).$$

Visible (resp. H_{α}) radiation

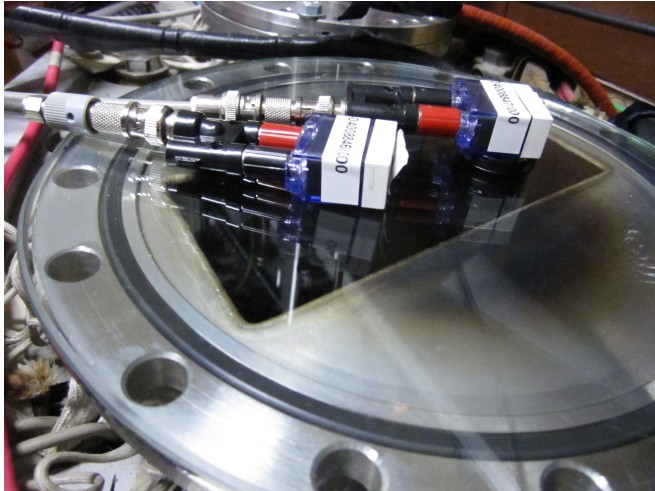

Golem Discharge

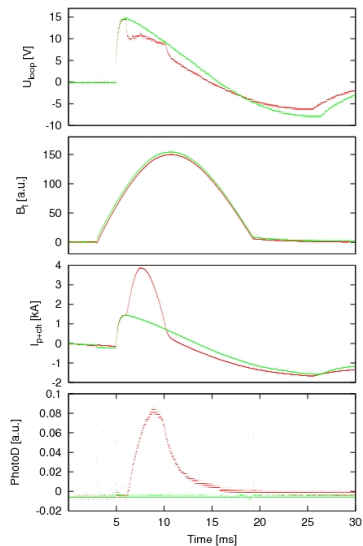
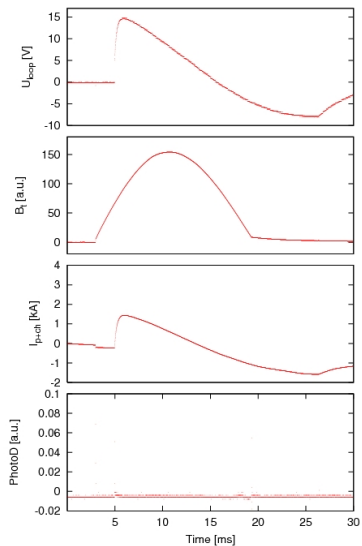

Outline

- 1 Introduction
- 2 Tokamak GOLEM - engineering scheme
- 3 Tokamak GOLEM - diagnostics
- 4 Data access**
- 5 Data manipulation
- 6 Possible tasks
- 7 Conclusion

GOLEM basic Data Acquisition System (DAS)

- $U_I, U_{B_t}, U_{I_{p+ch}}, I_{rad}, I_{H_{\alpha rad}}, I_{HXR}$.
- $\Delta t = 1\mu s / f = 1MHz$.
- Integration time = 40 ms,
thus DAS produces 6 columns \times
40000 rows data file.
- Discharge is triggered at 5th
millisecond after DAS to have
a zero status identification.



Data file example, DAS $\Delta t = 10\mu s / f = 100kHz$ (neutral gas into plasma breakdown focused)

t	U_{loop}	$U \frac{dB}{dt}$	$U \frac{d(I_{pl+ch})}{dt}$	I_{rad}
:	:	:	:	:
:	:	:	:	:
first	\approx	870	lines ..	
:	:	:	:	:
:	:	:	:	:
0,008760	2,062738	0,170025	0,024531	0,003930
0,008770	2,052438	0,163909	0,018415	0,003930
0,008780	2,040528	0,131720	0,020025	0,004252
0,008790	2,028296	0,161012	0,022600	0,004574
0,008800	2,017995	0,168416	0,023887	0,003930
0,008810	2,003510	0,174853	0,028394	0,004252
0,008820	1,984519	0,159081	0,032256	0,004252
0,008830	1,964561	0,128823	0,042557	0,004896
0,008840	1,945892	0,177107	0,033222	0,005218
0,008850	1,928510	0,171634	0,036441	0,004574
0,008860	1,908552	0,161978	0,051892	0,004896
0,008870	1,890848	0,164231	0,047385	0,005540
0,008880	1,876041	0,159403	0,039338	0,005218
0,008890	1,860591	0,178394	0,039982	0,005861
0,008900	1,847071	0,173244	0,049638	0,006183
0,008910	1,834196	0,156506	0,052857	0,006505
0,008920	1,815526	0,162300	0,051248	0,006505
0,008930	1,792672	0,181935	0,059295	0,006827
:	:	:	:	:
:	:	:	:	:
next	\approx	3100	lines ..	
:	:	:	:	:

GNU Wget is a free software package for retrieving files using HTTP, HTTPS and FTP, the most widely-used Internet protocols. It is a non-interactive commandline tool, so it may easily be called from scripts, cron jobs, terminals without X-Windows support, etc.

- Runs on most UNIX-like operating systems as well as Microsoft Windows.
- Homepage: <http://www.gnu.org/software/wget/>
- Basic usage:
 - To get Uloop: `wget http://golem.fjfi.cvut.cz/utils/data/<#ShotNo>/loop_voltage`
 - To get whole shot: `wget -r -nH -cut-dirs=3 -no-parent -l2 -Pshot http://golem.fjfi.cvut.cz/operation/shots/<#ShotNo>`

Data access

All the recorded data and the settings for each shot are available at the GOLEM website. The root directory for the files is:

```
http://golem.fjfi.cvut.cz/shots/<#ShotNo>/
```

Basic data of the shot series are collected at a page to be reached at:

```
http://golem.fjfi.cvut.cz/operation/tasks/<session>/
```

Actual discharge has the web page:

```
http://golem.fjfi.cvut.cz/shot/0.
```

Actual session has the web page:

```
http://golem.fjfi.cvut.cz/operation/currentsession.
```

Availability of data

<http://golem.fjfi.cvut.cz/shots/#ShotNo/Data.php>

GOLEM » Shot #14005 » [previous](#) | [next](#) | [current](#)

Data

[\[Template source\]](#)

Diagnostics

- Figures:
 - raw data: <http://golem.fjfi.cvut.cz/shots/14005/basicdiagn/graphpresb.png>
 - integrated data (lch+p): <http://golem.fjfi.cvut.cz/shots/14005/basicdiagn/graphpresi.png>
 - integrated data (lp): <http://golem.fjfi.cvut.cz/shots/14005/basicdiagn/graphpresb.png>
 - zoomed data: <http://golem.fjfi.cvut.cz/shots/14005/basicdiagn/graphpresb.png>

List of all available data in Pygolem

See more details about the pygolem interface

Accessible data: [\[data_configuration.cfg\]](#) [\[config.py\]](#) - (more details, all data)

Identifier	File name	Units	Description
breakdown_field (0.0846 T)↓	BreakDownBt	Magnetic flux density [T]	Toroidal mag. field during breakdown
breakdown_probability (94 %)↓	breakdown_probability	Probability [%]	Probability of breakdown using SVM
breakdown_rate (txt)↓	breakdown_rate	Time [s]	Characteristic plasma current grow time

golem.fjfi.cvut.cz/shots/14005/basicdiagn/graphpresb.png

Outline

- 1 Introduction
- 2 Tokamak GOLEM - engineering scheme
- 3 Tokamak GOLEM - diagnostics
- 4 Data access
- 5 Data manipulation**
- 6 Possible tasks
- 7 Conclusion

Plot 4665 U_{loop} graph

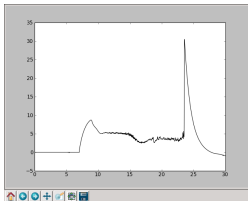

python

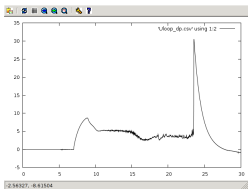

gnuplot

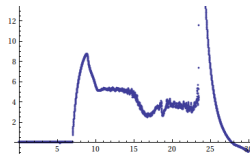

mathematica

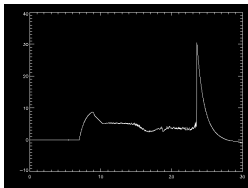

idl

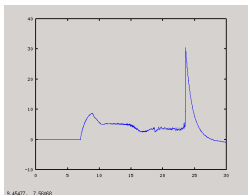

octave

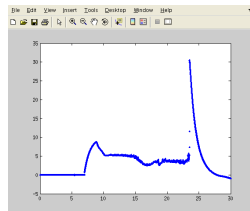

matlab

Matlab

```
%THIS IS NOT TESTED!! It may have bugs, sorry.
ShotNo=14000;
baseURL='http://golem.fjfi.cvut.cz/utils/data/';
diagnPATH='/loop_voltage';
%Create a path to data
dataURL=strcat(baseURL,int2str(ShotNo),diagnPATH);
% Write data from GOLEM server to a local file
urlwrite(dataURL,'loop_voltage');
% Load data
data = load('loop_voltage', "\t");
% Plot the graph in ms
plot(data(:,1)*1000, data(:,2), '.');
%exit;

% command line execution:
% matlab -nosplash -nodesktop -r Uloop
```

Octave

```
ShotNo=14000;
baseURL='http://golem.fjfi.cvut.cz/utis/data/';
diagnPATH='/loop_voltage';
%Create a path to data
dataURL=strcat(baseURL, int2str(ShotNo),diagnPATH);
% Write data from GOLEM server to a local file
urlwrite(dataURL, 'loop_voltage');
% Load data
data = dlmread('loop_voltage', "\t");
% Plot the graph in ms units
plot(data(:,1)*1000, data(:,2)) ;
%exit;

% command line execution:
% octave —persist Uloop.m
```

Gnuplot

```
set macros;
ShotNo = "14000";
baseURL = "http://golem.fjfi.cvut.cz/utils/data/";
diagnPATH = "/loop_voltage";
#Create a path to data
DataURL= "@baseURL@ShotNo@diagnPATH";
#Write data from GOLEM server to a local file
!wget -q @DataURL;
#Plot the graph from a local file
set datafile separator "\t";
plotstyle = "with_lines_linestyle_-1"
plot 'loop_voltage' using 1:2 @plotstyle;
exit;

# command line execution:
# gnuplot Uloop.gp -persist
```

Python

Download script on a linux computer

```
wget http://golem.fjfi.cvut.cz:5001/(cont.)  
(cont.)_showraw/SW/pygolem/golem_data.py  
ipython
```

Simple example:

Plot one signal:

```
from golem_data import golem_data  
from matplotlib.pyplot import *  
obj = golem_data(10011, 'loop_voltage')  
plot(obj.tvec, obj.data)  
show()
```

Mathematica

```
baseURL = "http://golem.fjfi.cvut.cz/utils/data/";  
ShotNo = 14000;  
diagnPATH = "/loop_voltage";  
dataURL = baseURL <> ToString[ShotNo] <> diagnPATH;  
dataimp=StringSplit[Import[dataURL, "List"], "\t", All]  
data = ToExpression[dataimp];  
graf=ListPlot[data]  
Export["graf.png", graf]
```

(command line execution: *)*

(mathematica Uloop.ma *)*

Excel

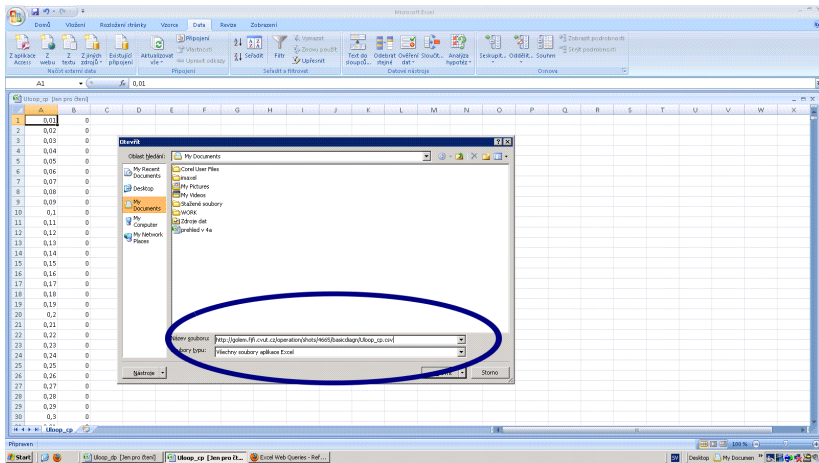

File→Open→ [http://golem.fjfi.cvut.cz/](http://golem.fjfi.cvut.cz/utils/data/14000/loop_voltage)

[utils/data/14000/loop_voltage](http://golem.fjfi.cvut.cz/utils/data/14000/loop_voltage)

Linux bash + Gnuplot

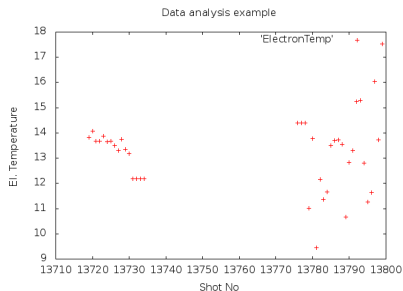

```
#!/bin/sh
```

```
base=http://golem.fjfi.cvut.cz/Utils/data/  
diagn=/electron_temperature_max
```

```
for i in `seq 13719 13734` `seq 13776 13799`;
```

```
do
```

```
  echo -n "$i"\t";
```

```
  wget -q -O - $base$i$diagn;
```

```
  done > ElectronTemp;
```

```
echo "\
```

```
set xlabel 'Shot_No';\
```

```
set ylabel 'El. Temperature';\
```

```
set title 'Data analysis example'
```

```
plot 'ElectronTemp' | gnuplot -persist
```

Outline

- 1 Introduction
- 2 Tokamak GOLEM - engineering scheme
- 3 Tokamak GOLEM - diagnostics
- 4 Data access
- 5 Data manipulation
- 6 Possible tasks**
- 7 Conclusion

Breakdown studies

Goal: Investigate probability of plasma breakdown (creation of plasma), mainly the role of the working gas and its pressure, breakdown electric field and its orientation.

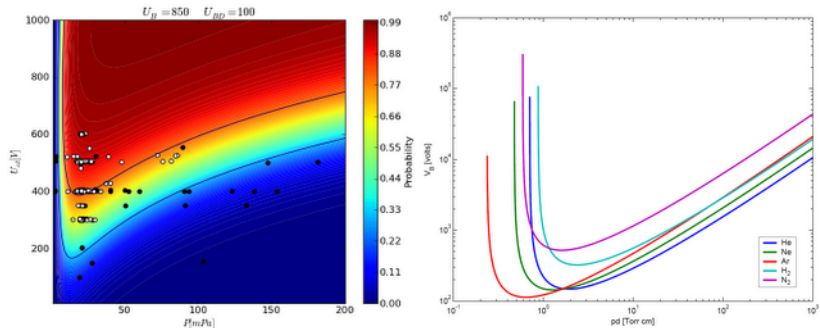

Left: Probability of breakdown in the tokamak GOLEM depending on discharge setup parameters: voltage U_{CD} applied to charge current drive capacitor bank and working gas pressure p_{H_2} . Right: Examples of Paschen Curves (see e.g. wiki [8]).

Isotopic studies

Goal: Differences between discharges in H and He as working gas can be analyzed and explained. Which plasma parameters are influenced by higher mass of the main species particles and which are influenced by much higher ionization energy of He can be also investigated.

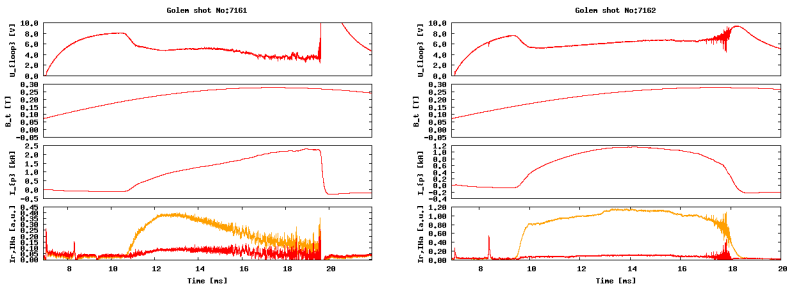

Evolution of main plasma parameters in
right) Hydrogen and left) Helium plasma.

Plasma position studies via magnetic diagnostic

Goal: Determinate the plasma (vertical and horizontal) position using two methods: approximation of the straight conductor and approximation coming from Grad-Shafranov equation from Mirnov coils signals.

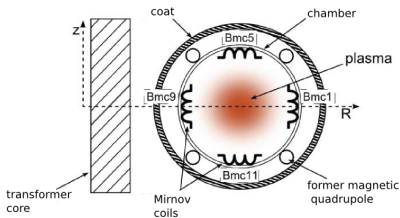

GOLEM Shot #5661 - Plasma Position

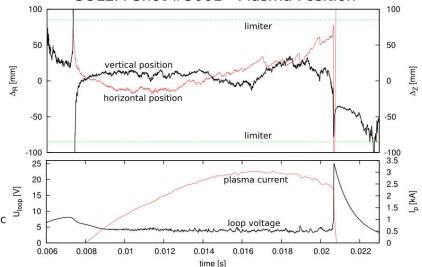

Left: Poloidal cross-section of the tokamak with the places of the 4 Mirnov coils. Right: Vertical and horizontal time evolution of plasma centre.

Determination of plasma resistance and electron temperature

Goal: Automate the calculation of central electron temperature via Spitzer formula (see e.g. GolemWiki [3] or [4] or [2]) and find the regime with the highest value of this parameter.

The central electron temperature (T_{e0}) is calculated from equation based on Spitzer's resistivity formula:

$$T_{e0}(t) = \left(\frac{R_0}{a^2} \frac{8Z_{eff.}}{1544} \frac{1}{R_{pl}(t)} \right)^{2/3}, \quad (1)$$

where $R_{pl}(t)$ is in Ohms, distances are in meters and we get $T_{e0}(t)$ in electronvolts.

First wall conditioning – baking of the vessel and glow discharge influence on plasma performance

Goal: Plasma properties are degraded by flow of neutrals from the walls. Therefore, clear high temperature plasma can be achieved only with pure vessel walls. The cleanness of the walls can be influenced by baking of the tokamak chamber and also by glow discharge in hydrogen or helium. The goal is to find the best cleaning strategy to achieve the best plasma.

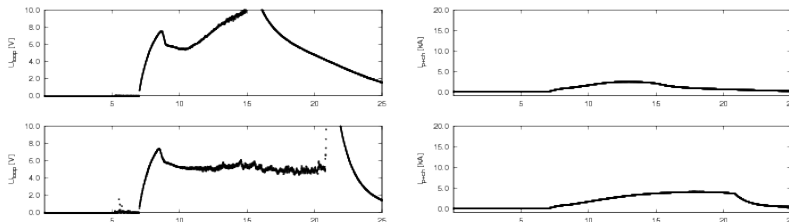

Evolution of main plasma parameters

upper) *before* and bottom) *after* vessel conditioning via baking.

"Tomography"

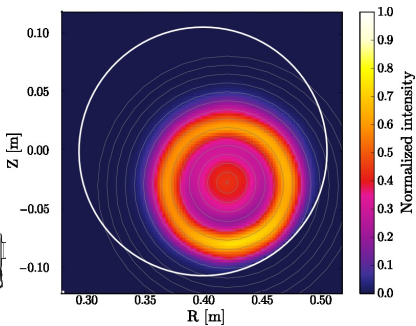
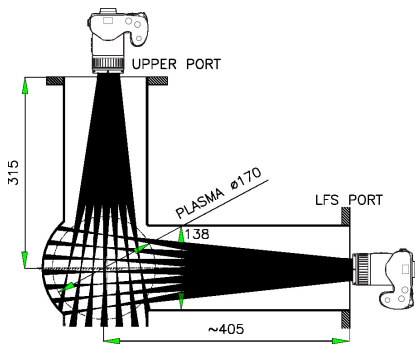

(HTPD conference Monterey + RSI 2012)

HXR

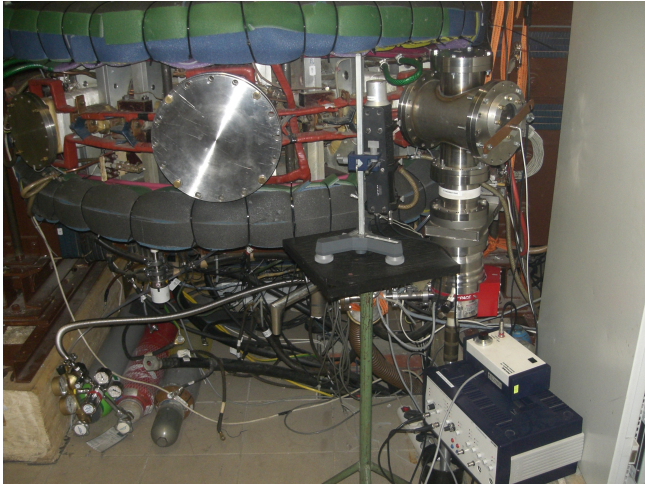

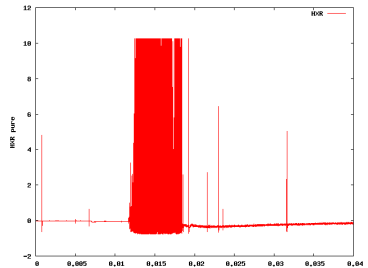
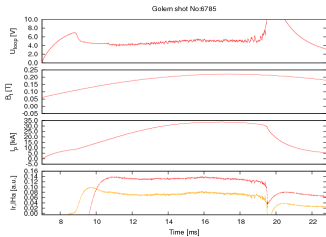
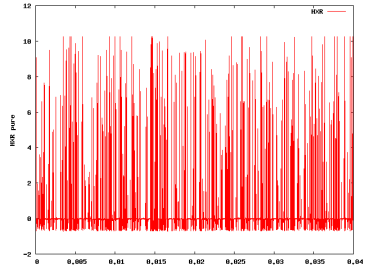
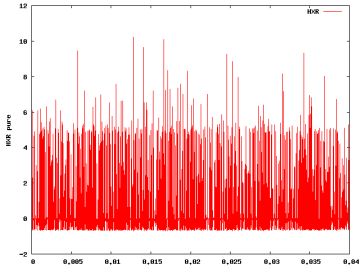

Rake probe (2012)

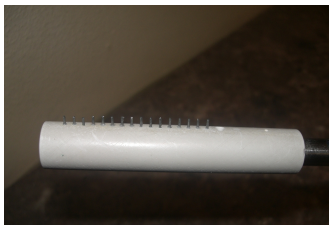
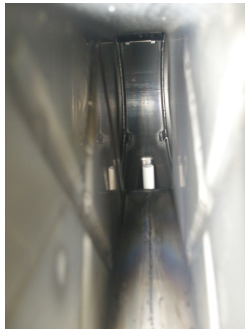
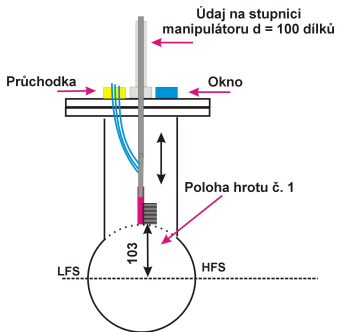

Rake probe (2012) - results

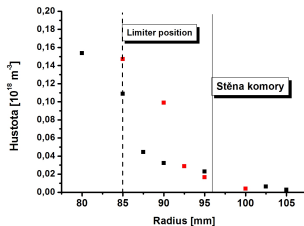
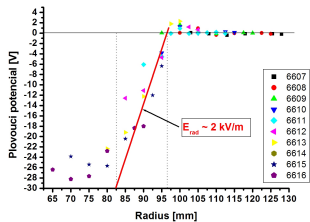
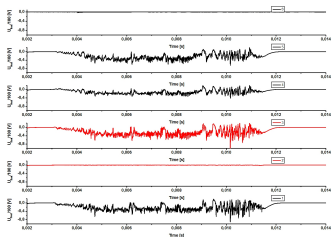

Spectra

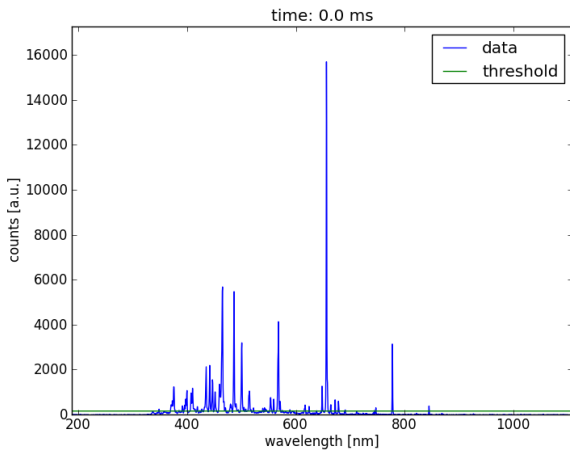

Outline

- 1 Introduction
- 2 Tokamak GOLEM - engineering scheme
- 3 Tokamak GOLEM - diagnostics
- 4 Data access
- 5 Data manipulation
- 6 Possible tasks
- 7 Conclusion**

- Everything via <http://golem.fjfi.cvut.cz/current>
 - This presentation
 - Control rooms
 - Contact: Vojtech Svoboda, +420 737673903,
 - possible chat: vojtech.svob@gmail.com
- Measurement days: Tuesday and Wednesday.

Looking forward to see you on Tuesday and Wednesday

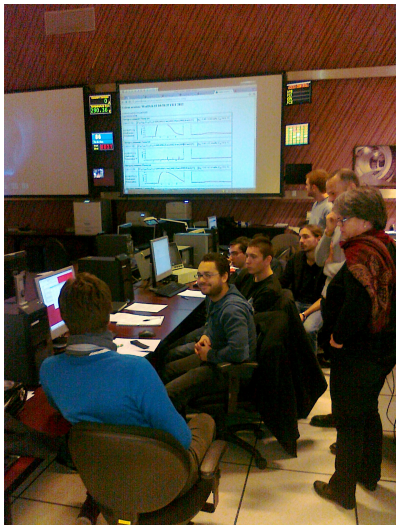

Any shot from mobile phone?

The call

Author will highly appreciate any comments, suggestions to the material presented. Especially we are looking forward to enrich the list of possible scripts in graphing systems (e.g. maple, origin, science, root, ...). Thank you in advance. Vojtech Svoboda, <mailto:svoboda@fjfi.cvut.cz>

Acknowledgement

Acknowledgement

The financial support by FUSENET, MSM 6840770039, MSM 6840770014 and A1581 is acknowledged.

Special thanks to the GOLEM team (students, teachers, technicians)

Edita Bromova, Vladimir Fuchs, Ondrej Grover, Igor Jex, Jindrich Kocman, Jaroslav Krbec, Borek Leitl, Tomas Markovic, Lukas Matena, Michal Odstrcil, Tomas Odstrcil, Ondrej Pluhar, Gergo Pokol, Jan Stockel, Tereza Ruzickova, Gabriel Vondrasek, Ondrej Vrba, Frantisek Zacek and Jiri Zara.

- [1] E. Bromova et al. "The GOLEM Tokamak for Fusion Education". In: *Europhysics Conference Abstracts. 38th EPS Conference on Plasma Physics (online: <http://ocs.ciemat.es/EPS2011PAP/pdf/P1.021.pdf>)*. Vol. 35G. 2011. ISBN: 2-914771-68-1.
- [2] Brotankova, J. "Study of high temperature plasma in tokamak-like experimental devices". In: (PhD. thesis 2009).
- [3] Golem Wiki contributors. *Central Electron Temperature via Spitzer Formula*. [Online; accessed 30-January-2014]. 2013. URL: <http://golem.fjfi.cvut.cz/wiki/Theory/Basics/CentralElectronTemperatureSpitzerFormula/index>.
- [4] *NRL plasma formulary*. Naval Research Laboratory, 2009.
- [5] V. Svoboda et al. "Former Tokamak CASTOR becomes remotely controllable GOLEM at the Czech Technical University in Prague". In: *Europhysics Conference Abstracts*.

37th EPS Conference on Plasma Physics (online: <http://ocs.ciemat.es/EPS2010PAP/pdf/P2.111.pdf>).
Vol. 34A. 2010. ISBN: 2-914771-62-2.

- [6] V. Svoboda et al. "Multi-mode Remote Participation on the GOLEM Tokamak". In: *Fusion Engineering and Design* 86.6-8 (2011), 1310–1314. ISSN: 0920-3796. DOI: [10.1016/j.fusengdes.2011.02.069](https://doi.org/10.1016/j.fusengdes.2011.02.069).
- [7] Tokamak GOLEM team. *Tokamak GOLEM at the Czech Technical University in Prague*. <http://golem.fjfi.cvut.cz>. 2007.
- [8] Wikipedia. *Paschen's law* — *Wikipedia, The Free Encyclopedia*. [Online; accessed 30-January-2014]. 2013. URL: http://en.wikipedia.org/w/index.php?title=Paschen%27s_law&oldid=578552709.